



AMAZONE

ZG-TS ZG-B



**AMAZONE spreaders
fulfil all European
environmental
standards**

ZG-TS and ZG-B trailed fertiliser spreaders

Perfectly matched to your needs!



Uniform plant growth is the most important requirement for producing high yields. No single location can offer plants uniform growing conditions across the whole field. To ensure that plants receive balanced nutrition, the application of mineral fertilisers must therefore always be adapted to the individual requirements. The decisive factor for maximising fertiliser efficacy is therefore not only the selection of the optimum fertiliser, but also, and most importantly, the careful and precise distribution of those nutrients.

ZG-TS

The professional fertiliser spreader for granular material

Model	Hopper volume
ZG-TS 7501 ProfisPro	7,500 l
ZG-TS 10001 ProfisPro	10,000 l

Range of application

- ✔ Mineral fertiliser
- ✔ Pelleted fertiliser
- ✔ Seeds
- ✔ Slug pellets

ZG-B

The perfect all-rounder

Model	Hopper volume
ZG-B 5500	5,500 l
ZG-B 8200	8,200 l

Range of application

- ✔ Mineral fertiliser
- ✔ Pelleted fertiliser
- ✔ Earth-moist fertilisers

Precise fertilisation, more yield

	Page
ZG-TS The advantages at a glance	4
ZG-TS Overview	6
ZG-TS Hopper	8
ZG-TS ProfisPro weighing technology	10
ZG-TS Steering with braking force compensation	14
ZG-TS Spreading disc drive options	16
ZG-TS Soft Ballistic System pro	18
ZG-TS Spreading system	20
ZG-TS AutoTS border spreading system	26
ZG-TS HeadlandControl	30
ZG-TS ArgusTwin	32
ZG-TS WindControl	36
ZG-TS Equipment	38
ZG-TS ISOBUS	42

ZG-B The advantages at a glance	52
ZG-B Overview	54
ZG-B ZG-B Special ZG-B Super	56
ZG-B ZG-B Drive	58
ZG-B Spreading system	60
ZG-B Equipment	62
ZG-TS/ZG-B Truck demount spreader	64
AMAZONE Service	66
Spreader Application Center EasyCheck	68
Technical data	70

The ZG-TS trailed spreader

More output. More precision. Maximum efficiency.

Up to **650 kg/min**

Working widths of up to

54 m



The advantages at a glance:

- ⊕ Precise spread patterns in working widths of up to 54 m with and up to 128 part-width sections
- ⊕ Maximum work rates at application rates of 650 kg/min and operational speeds of up to 30 km/h
- ⊕ ProfisPro on-line weighing system – for constant control of the application rate
- ⊕ Fill management with the external fill level indicator lights ensures the quick and accurate loading by just one person
- ⊕ Automatic checking and adjustment of the lateral distribution via the ArgusTwin spread pattern monitoring
- ⊕ Easy changeover between side, border and water course spreading from the tractor cab thanks to the integrated AutoTS border spreading system on both sides
- ⊕ New steering axle, true track-following of the spreader via axle steering with a steering angle of up to 28°
- ⊕ Equipment that suits every requirement: variable spread widths, agitation, internal hopper lighting, mobile or digital calibration kit, camera system, ...

7,500 or 10,000 litres
hopper capacities

Up to **30 km/h**
operational speed

Up to **60 km/h**
transport speed



Steering axle
with a steering angle of up to **28°**



MORE INFORMATION
www.amazone.net/zg-ts

ZG-TS – the new standard



SPEED
spreading

❗ **“Precise and stylish!”**

(“profi” – test report ZG-TS 01 ProfisPro · 06/2018)

The new ZG-TS 01 trailed spreader, in hopper capacities of either 7,500 l or 10,000 l, capable of working widths of up to 54 m and operational speeds of up to 30 km/h, provides the means for even higher outputs. The integrated AutoTS border spreading system and GPS-Switch automatic part-width section control of up to 128 part-width sections allows for very precise spreading results. The on-line ProfisPro weighing system ensures the continuous monitoring of the application rate, and the ArgusTwin monitors the pattern for the perfect lateral distribution even with changeable fertiliser or adverse weather conditions.

Recognised by Awards so many times over – Spreads success – Harvest success

WindControl system:

in accordance with Prof. Dr. Karl Wild
HTW Dresden

Silver Agritechnica
Gold AGROSALON



ArgusTwin:

The eyes of the spreader.
Automatic spread pattern monitoring

Gold Agritechnica



EasyCheck:

The digital and mobile calibration kit

Silver Agritechnica



With its joint teamwork of design and performance, the ZG-TS 10001, entered into the “Farm Machinery” category, convinced and inspired the iF Jury which consists of experts and designers from all over the world. Among the evaluation criteria of the jury included the design quality, processing and material selection, degree of innovation and environmental compatibility, functionality and ergonomics, as well as visual effect and user safety.



The ZG-TS, the known quantity



Enormous work rates

With hopper capacities of 7,500 l and 10,000 l, the ZG-TS models are especially efficient and ideal for large farm sizes which focus in particular on increased precision. Thanks to their size, valuable travelling and loading times are saved. Due to the large hopper opening, the loading procedure can also be carried out very comfortably via a front end loader or from a bulk filling system. The belt floor, automatically centred to the middle, ensures the optimum material flow. The low-maintenance floor belt is of course automatically controlled.

Benefits of the base hopper

- ✔ Low hopper centre of gravity
- ✔ Low filling height
- ✔ Large filling opening
- ✔ Low wearing rubber floor belt
- ✔ Automatic belt floor control

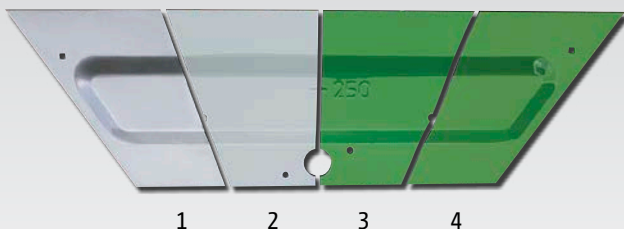

- ✔ The high-quality, multi-layer paint finish ensures that top, long-lasting quality
 - 1) sheet steel
 - 2) zinc phosphate (galvanising layer)
 - 3) KTL priming coat
 - 4) top coat

Everything flows smoothly thanks to the optimum hopper shape

Thanks to the sophisticated hopper shape of the ZG-TS, it has an optimum centre of gravity which significantly counteracts the negative support loads. The steep hopper walls without corners or edges ensure the optimum flow of material, even in sloping terrain, also the cleaning procedure is considerably eased. In addition, there is also an increased range of movement for the steering axle which has steering angles of up to 28 °.

Benefits of the hopper design

- ✔ Optimum material flow even in sloping terrain
- ✔ Simple cleaning procedure
- ✔ Generous space for the axle steering
- ✔ Sophisticated centre of gravity to avoid negative support loads
- ✔ High ground clearance

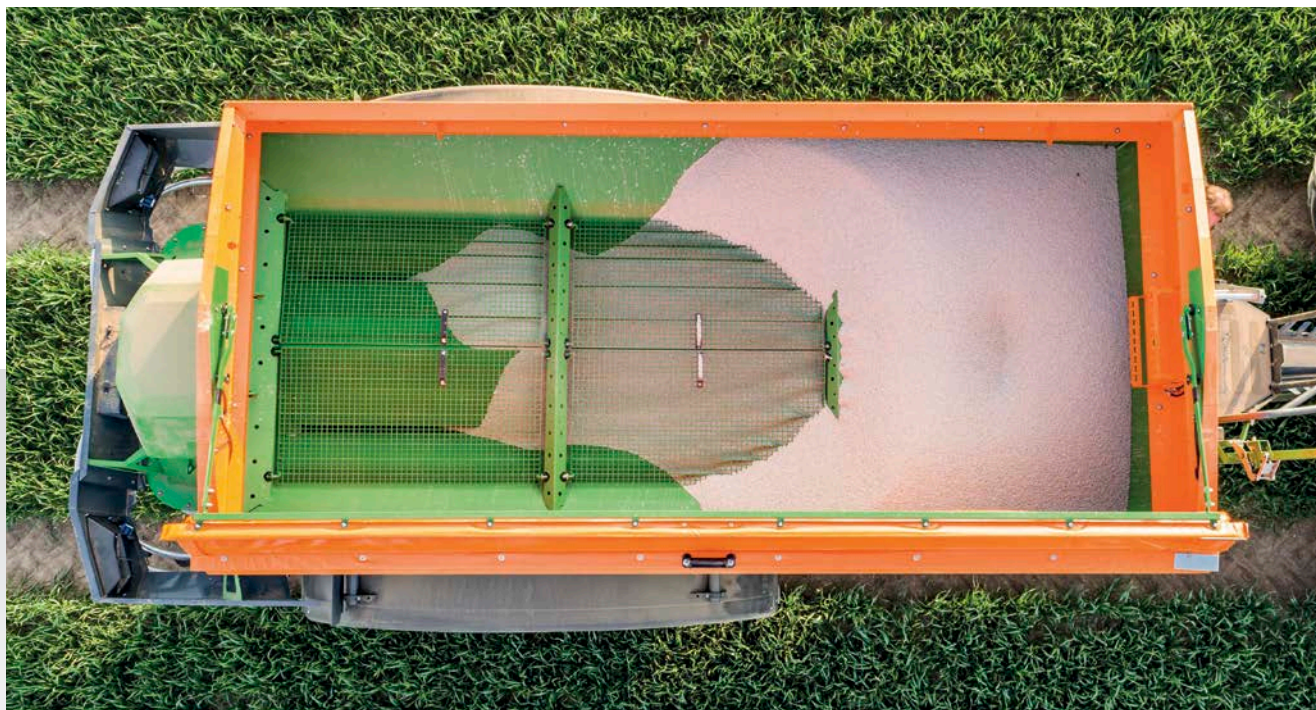
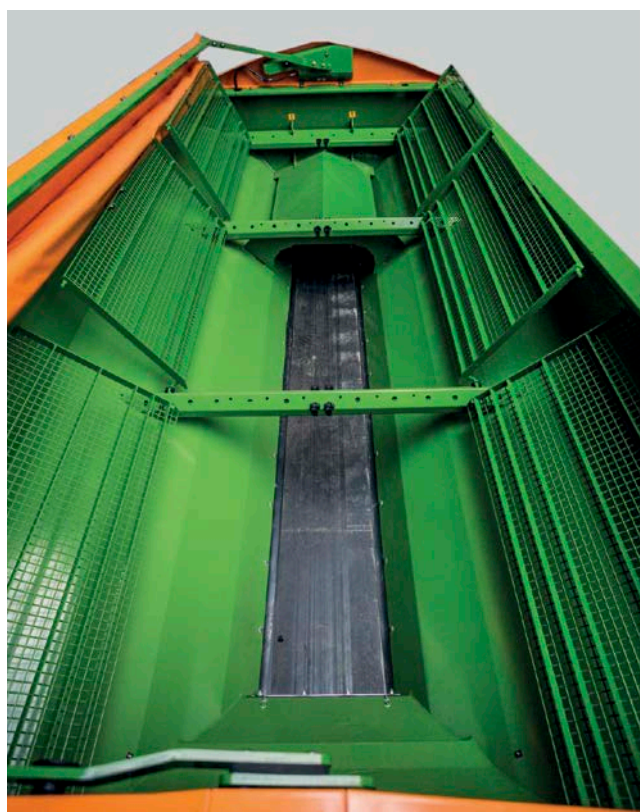

Unique weighing technology – ProfisPro

He who weighs wins!



Perfect weighing system

With the ProfisPro, AMAZONE introduces a new weighing system, combining maximum comfort with optimised work performance. In addition to its core function where the on-line weighing function regulates the application rate, the weighing signals are used for other functions.

Intelligent technology

A new integrated weigh frame connects the hopper to the weigh frame via four weigh cells. This is completely separate to the chassis. Thus, there are no weight measuring points which are influenced by the traction forces of the tractor. The result is a high frequency and precise on-line-weighing procedure. A tilt sensor additionally compensates for the inclination of the machine on slopes. This signal is also used to register any tendency of the ZG-TS to drift down on a slope and, via the steering axle, to counter-steer the machine back in track.



On-line calibration

The signals produced from the weighing system are used for the on-line calibration and thus enables automatic regulation of the application rate via the metering shutter slides.

Benefits of on-line calibration

- ✔ Enter the spread rate and drive off
- ✔ Reliable measuring values
- ✔ Automatic regulation of the metering shutter slides



Intelligent fill management

ProfisPro is particularly clever with its intelligent fill management during loading. Without the use of an external scale, the system gives precise information about the load condition at all times, thus preventing overloading and empty runs. And so, as a filling aid, or by the continuous measurement of the hopper contents, ProfisPro sets new standards.

Benefits of fill management

- ✔ Reliable filling aid
- ✔ Reliable fill level measurements even without using an external balance
- ✔ Avoidance of unnecessary empty travelling and residues



Automatic load-dependent braking force control

To determine the load-dependent braking force one also relies on the signal of the new on-line weighing system. With the reliable measuring results, determined by ProfisPro, the optimum braking force for all load ranges can be derived so that the braking effect can be matched very sensitively.

Benefits load-dependent braking force control

- ✔ Very comfortable and safe in road travel
- ✔ Maximum safety on the headland and in sloping terrain

Intelligent fill management

Your reliable assistant!



Optimum load distribution

Thanks to the real time measuring via the ProfisPro weighing system, the axle and support loads can be optimally utilised during the filling procedure.

This is because during the filling procedure it is possible to see where the load is concentrated and thus prevent either the overloading of the axle or the drawbar.

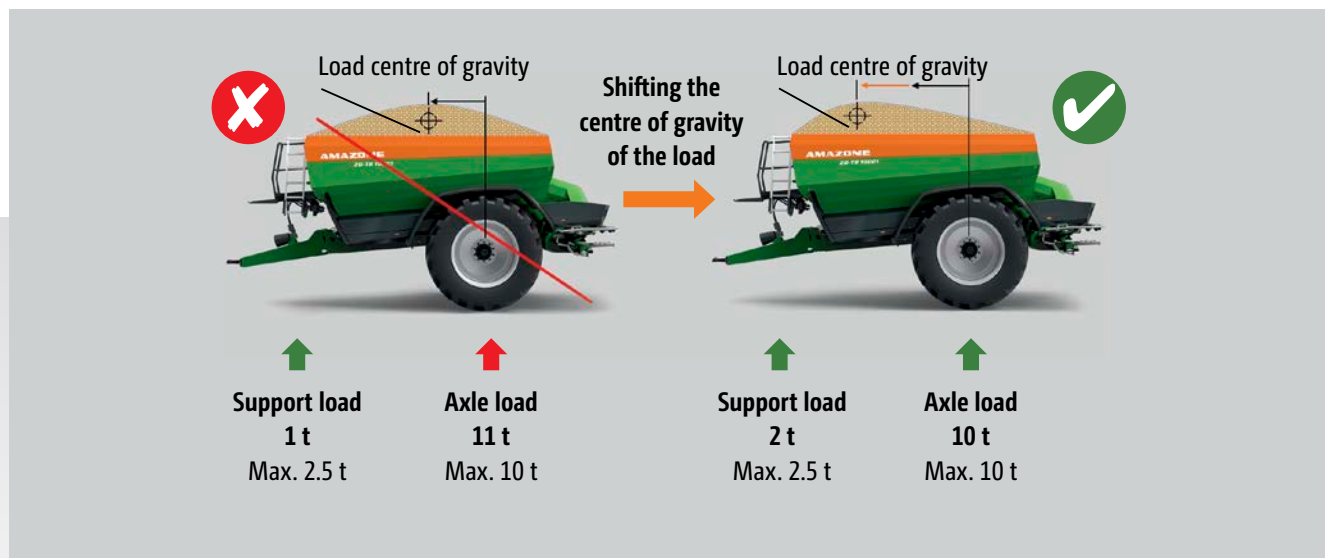



✔ Filling by just one person, very simple!

✔ If the work light illuminate constantly, the desired fill level has been reached

Filling aid

Operators will especially love the filling aid provided by the work lights and the ProfisPro weighing system. By means of first flashing work lights when the desired fill level is nearing and then continuous illumination when the fill level is reached, a second person, or the need for multiple checks, is avoided.

❗ “Via flashing signals the work lights [...] inform the driver of the filling vehicle as to the quantity filled – so a precise filling is possible“

(“profi“- test report ZG-TS 01 ProfisPro · 06/2018)



Filling menu – determination of the desired fill level



Manoeuvrable and comfortable

Perfect driving behaviour on the road and in the field



60 km/h

- ❗ “New for the fertiliser spreaders is the axle steering [...] making the machines manoeuvrable and ensures a true track-following”

(“profi” – test report ZG-TS 01 ProfisPro · 06/2018)

Greater comfort – gentle on the crop

- ✔ True track-following at track widths of 1.80 to 2.25 m
- ✔ Increased driving comfort due to sprung-suspended and height adjustable drawbar system
- ✔ Stable and robust chassis technology, designed for speeds of up to 60 km/h
- ✔ Automatic braking force regulation
- ✔ Oversized tyres reduce the ground pressure and allows operation even under the most arduous of conditions
- ✔ Wheel diameters of up to 2.05 m possible



Steering axle with a steering angle up to 28°



Braking force control via electronic braking system (EBS)

True-track axle steering

The ZG-TS trailed spreaders, equipped with the optional steering axle, provides a maximum steering angle of up to 28°. That means: At a track width of 1,800 mm and a tyre width of 520 mm, the true track-following is possible. The automatic steering even allows counter-steering on slopes. As soon as the spreading disc drive has been deactivated and a speed of 15 km/h is exceeded, the steering automatically stops to ensure the safe road transport at speeds of up to 60 km/h.

Benefits of axle steering

- ✔ Steering angle up to 28°
- ✔ Minimum turning radius of 4.5 m
- ✔ True track-following – for gentle crop treatment
- ✔ Counter-steering in sloping terrain

Automatic braking force control

In order to be safe on the road, even at high speeds and different load capacities, the ZG-TS offers an optional automatic load-dependent braking force control. The electronic braking system (EBS) receives the signal for determining the load-dependent braking force from the new on-line weighing system. Since the weighing system continuously determines the quantity in the hopper, the delivered braking force adapts automatically. Due to this the braking sensitivity is perfect for all load ranges. The ZG-TS also fulfils the requirements of the new EU braking regulations 167/2013.

Advantageous electronically-controlled braking system

- ✔ Load-dependent braking
- ✔ Comfortable and safe road travel
- ✔ Maximum safety on the headlands and on slopes

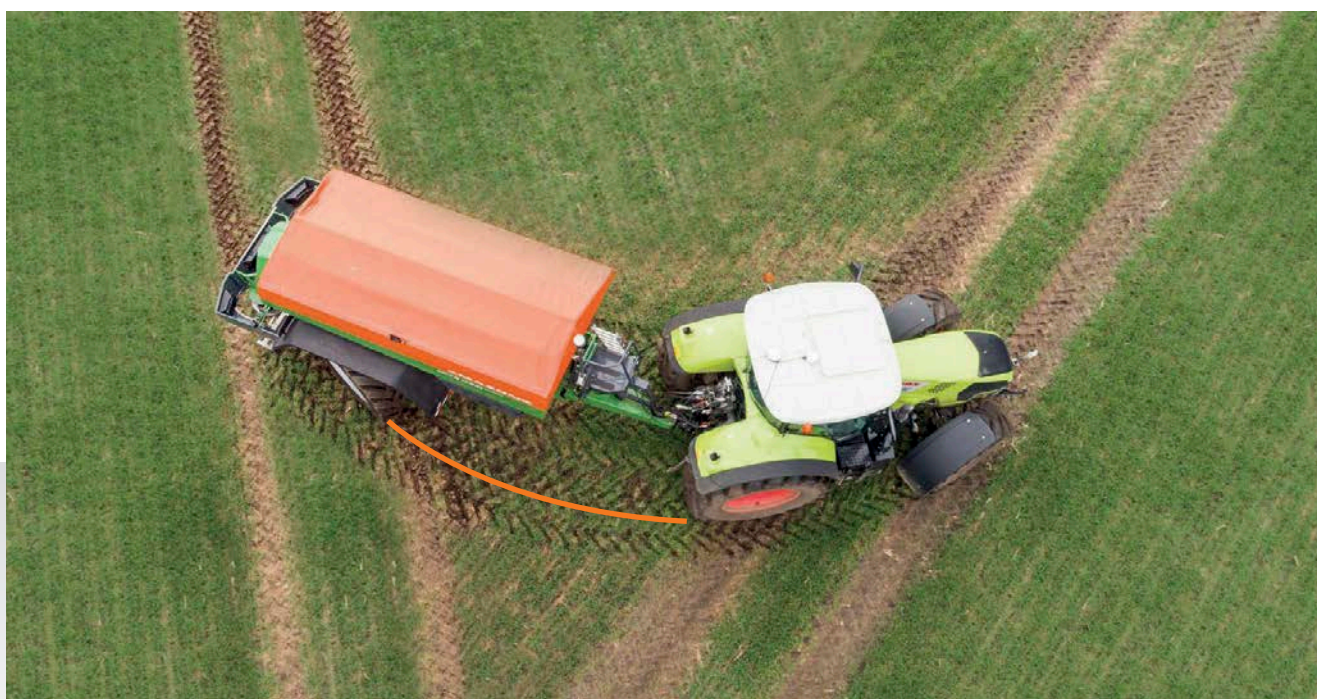

Spreading unit technology that is well thought through

Benefit from more than 100 years of experience



✔ Precise fertilisation, improved plant growth, more yield.

Hydraulic spreading disc drive

The hydraulic spreading disc drive allows operation irrespective of the engine speed of the tractor and the speed of the spreading discs can be varied individually. In this way, fuel is saved and a particularly comfortable and precise spreading is ensured. Also when border spreading, the spreader operates with different spreading disc speeds

so that, both in the overlap range and also at the field's border, the best possible lateral distribution can be achieved.

Depending on the operator terminal, the hydraulic drive offers the switching of up to 128 part-width sections.

The drive options

Suited to any tractor size



✔ Hybrid drive on-board hydraulics with additional pump

Hydro drive – the drive with Load-Sensing system

Spreaders with Hydro drive are fully supplied via the Load-Sensing system of the tractor. For tractors with sufficient oil supply the ISOBUS connecting cable is sufficient and the Load-Sensing system can operate the spreader at full functionality.

❗ “The consistently stable speed of the discs and also, above all, the possibility of different disc speeds is a dream. You only come to know, and appreciated the benefits, offered by the hydraulic system when you have used it”

(“profi“- Spreading units in practice “hydraulic or mechanical“- 06/2017)

Hybrid drive – maximum, efficiency even on smaller tractors

For spreaders with hybrid drive, approximately two thirds of the oil capacity come from the Load-Sensing system of the tractor and the other third is reused with the aid of a second pump in the return-flow to the tractor. For this, a hydraulic pump is driven directly via the tractor’s power take off shaft. This hybrid system allows the use of smaller tractors and is, at the same time, significantly lower priced than a normal on-board hydraulic system.

✔ Pressure filter as standard



Soft Ballistic System pro

For an even gentler fertiliser treatment



4 decisive advantages with SBS pro

Mineral fertilisers require an especially gentle treatment to ensure a precise distribution and accurate transport to the crop. Fertiliser which has been already damaged in the spreader can no longer be reliably distributed.

As a safety feature, AMAZONE Soft Ballistic System pro is integrated as standard. This means that the agitator, metering components and spreading discs are all optimally matched thus protecting the fertiliser and ensuring better yields.

1. Gentle guidance

The electrically driven star agitators in the hopper bottoms ensure an even fertiliser delivery onto the spreading discs. The slowly rotating, star shaped segments of the agitator evenly deliver the fertiliser to the relevant outlet opening. When the delivery system is adjusted, the agitator star rotates as well so that it is always perfectly positioned above the aperture. The agitator switches off automatically when the shutter slide is closed.

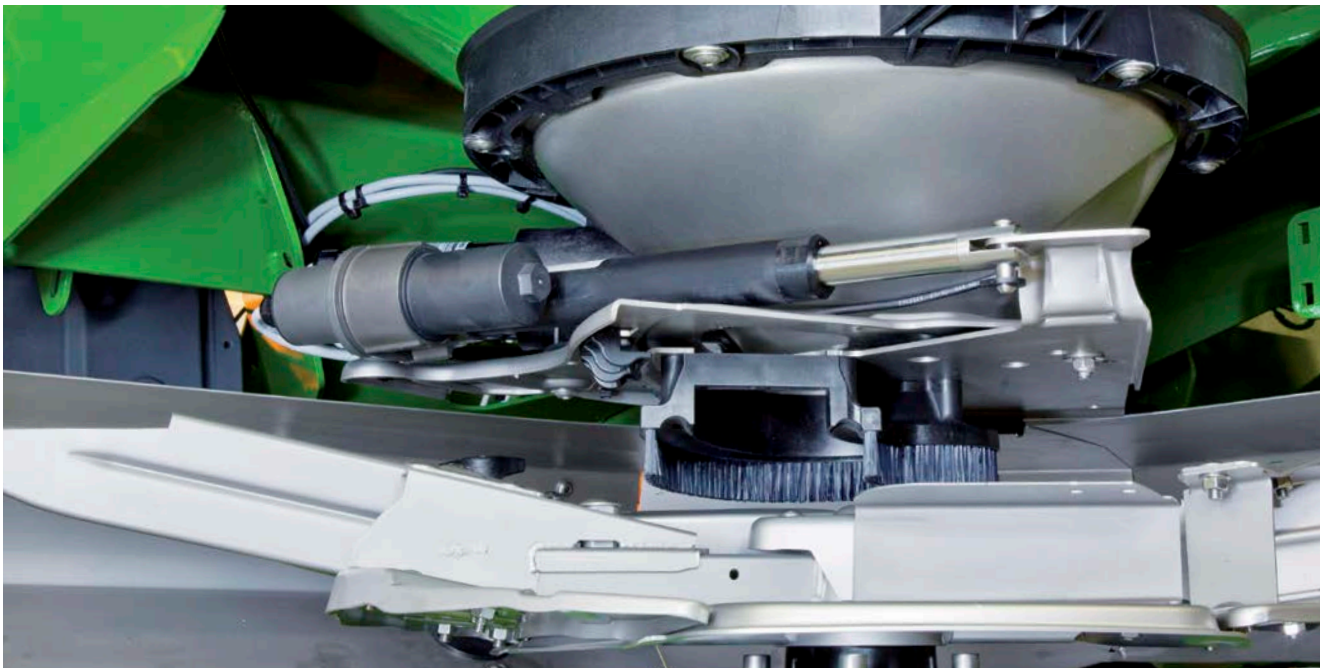

✔ Spreading system with delivery system, brush kit and spreading disc

2. Gentle delivery

Due to the delivery system, adjustment to the throwing width and throwing direction can be regulated. In addition, the working width can be adjusted each side individually by changing the disc speed. The fertiliser is fed on centrally at a low peripheral speed resulting in little fertiliser damage. The concentric delivery system adjustment results always in a gentle treatment of the fertiliser.

3. Gentle acceleration

With a standard disc speed from 600 rpm up to 900 rpm, the AMAZONE's Soft Ballistic System pro gently accelerates the fertiliser. Even fertiliser types with minimal breaking strength maintain their spreading properties and provide a clean, even spread pattern.

4. Gentle ejection

With the AMAZONE Soft Ballistic System pro, as little energy as possible is given to the fertiliser for an optimum trajectory and a precise spread pattern. So, the spreading vanes are optimally adjusted to a laid-back position.



TS spreading system

Perfection in every component, like clockwork

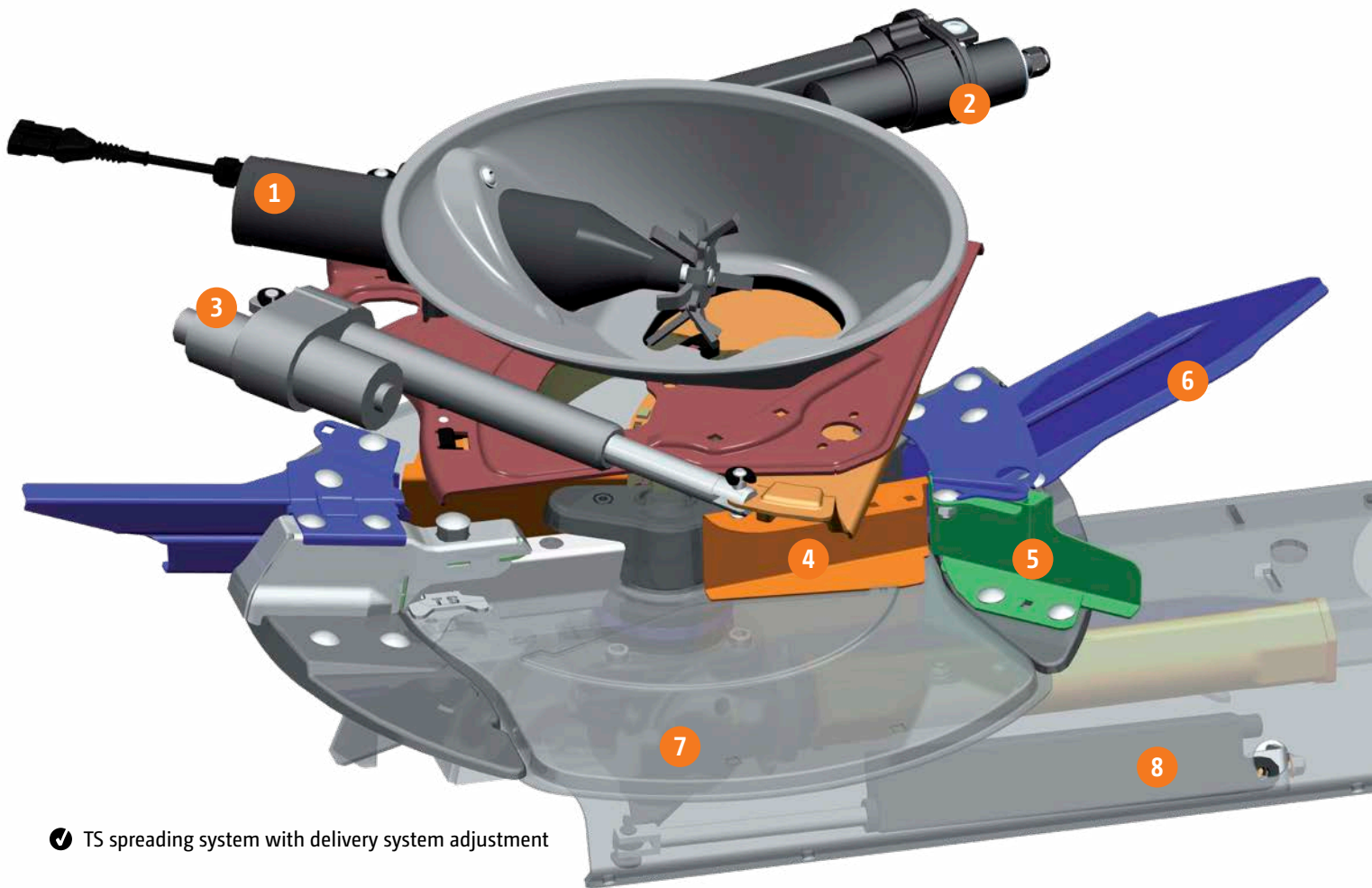

✔ TS spreading system with delivery system adjustment

Composition of the TS spreading system

- 1) electric agitator drive
- 2) electric setting motor for rotating the delivery systems
- 3) electric setting motor for the fertiliser metering
- 4) delivery vane
- 5) boundary spreading vane
- 6) normal spreading vane
- 7) AutoTS actuation
- 8) electric setting motor for AutoTS including function check

Characteristics of the TS spreading system

- ✔ High throwing width, still double-overlapping even at 36 m
- ✔ Integrated boundary spreading system
- ✔ High application rates (up to 10.8 kg/sec or 650 kg/min)

- ❗ “A 12V motor drives the agitator which rotates at 60 RPM. It switches off when the shutter is closed and it reverses as soon as a foreign object blocks the agitator.”

(dlz agrar magazine – Long term test ZA-TS 3200 Profis Hydro · 02/2017)



The agitator – soft-handling and gentle

The basic function of the agitator is to convey the fertiliser flow actively towards the outlet aperture so that a constant rate of fertiliser can be applied. Fertiliser lumps, which manage to pass the sieve, are, especially at low application rates, actively broken up via the star agitator which runs in the hopper bottom. If foreign objects reach the hopper tip and the agitator is subject to an overload, the relevant electric motor automatically reverses in combination with the relevant shutter slide and remedies the disturbance autonomously. The perfect teamwork of agitator and shutter slides becomes obvious on headlands or when spreading in wedges. As soon as one metering aperture is

completely closed, the agitator above stops automatically. In this way the valuable fertiliser is protected from being ground up.

The benefits of electric agitation

- ✔ two slow-running, fertiliser saving agitators; turning at just 60 rpm
- ✔ which switch off automatically as soon as the shutter slide is closed, also just to the one side and independently of each other
- ✔ that reverse automatically when blocked by a foreign object
- ✔ active delivery of the fertiliser flow to the outlet aperture

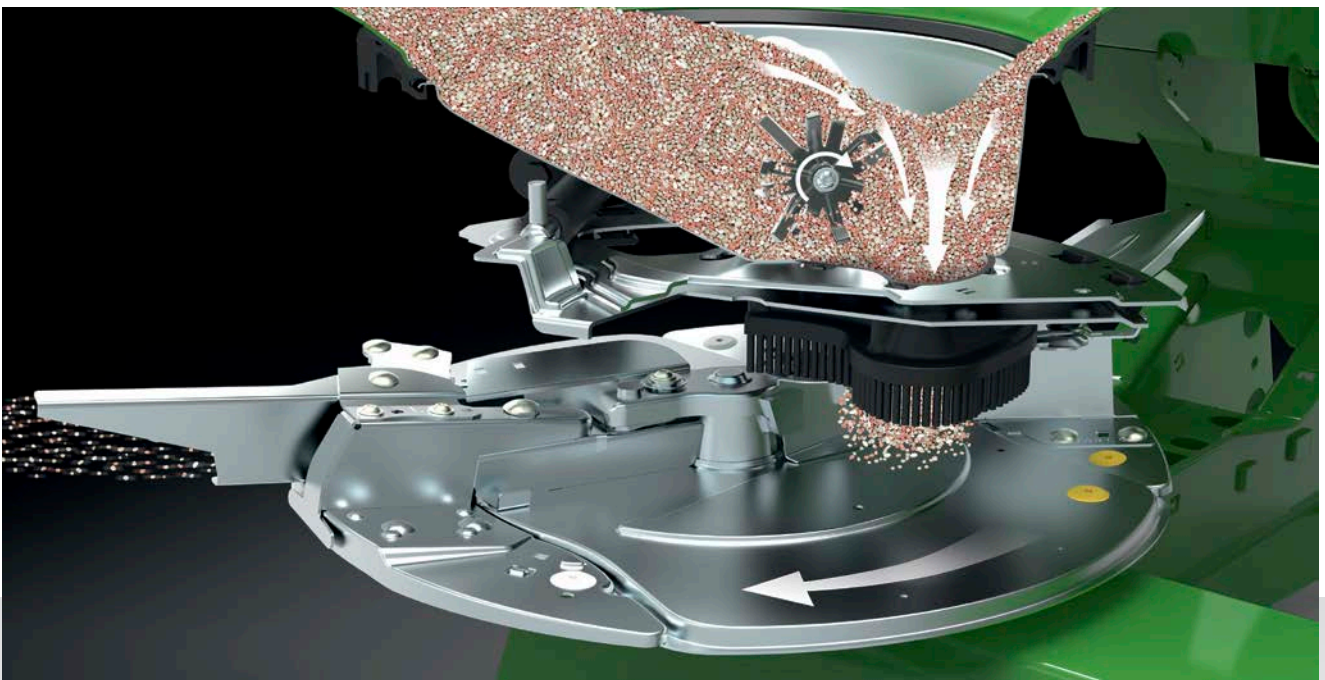

- ❗ “The electric agitators operate independently left or right and only when that shutter is opened”

(profi – Practice Test “Four fertiliser spreaders in comparison” · 01/2016)

The AMAZONE delivery system

For first-class spreading results

Concentric delivery system adjustment

Via the delivery system, the fertiliser is gently fed-on extremely close to the centre of the spreading disc. At this point, close to the centre of the disc; the peripheral speed is low resulting in a particularly gentle treatment of the fertiliser. For the adjustment of the spreading unit to different working widths and fertiliser types, the delivery system is swivelled electrically around the centre of the discs (concentrically). The distance between the feed-on point of the fertiliser and the centre of the disc always remains the same.

The swivelling of the delivery system provides you with a wide range of possible working widths; just three sets of spreading vanes cover working widths from 15 m to 54 m.



✓ Every TS spreading unit with electric delivery system adjustment is Argus ready

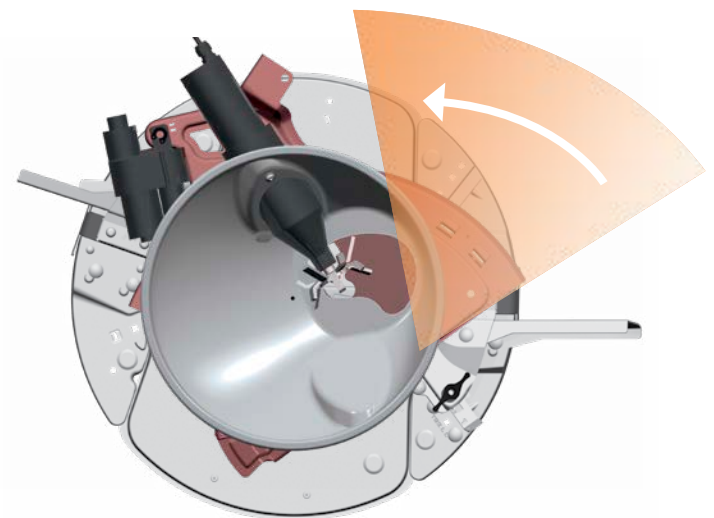
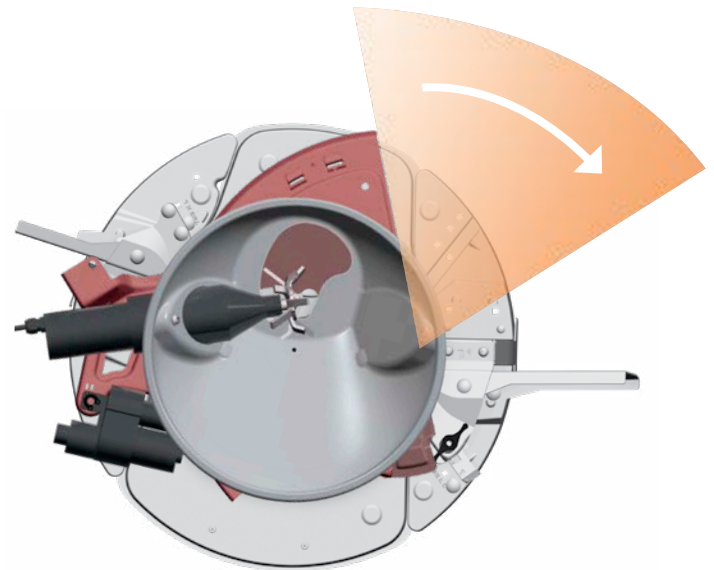

✓ The delivery system swivels around the centre of the disc

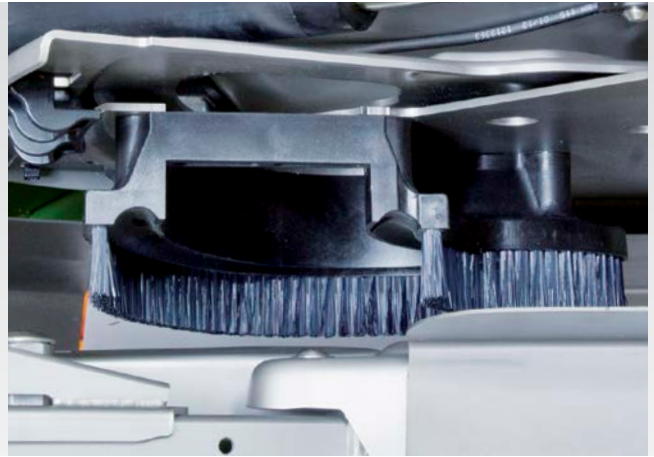

✔ Brush unit for a clean delivery onto the spreading discs

Ultra quick and precise! Electric setting motors

A spreader which, due to the high application rates and operational speeds possible, explores new dimensions in terms of work rates and which, of course, needs to perform extremely precisely at the same time, requires setting motors that function extremely quickly and exactly. Especially in applications, such as the automatic on/off switching at the headland or in wedges, spreading using application maps or with the continuous on-board monitoring (ArgusTwin and WindControl), the setting motors ensure the highest level demands are met.

Clean transfer – The brush unit

The bristles of the brushes which are fitted directly to the outlet apertures reach to the upper edge of the spreading vanes so that the fertiliser is safely delivered onto the disc.

Quantity effect-free metering aperture

If it is intended to spread a constant application rate it is necessary to match the size of the metering aperture to the prevailing operational speed. Thanks to the shutter slide, this task is fulfilled very quickly and sensitively. Due to the

kidney-shaped design of the metering aperture, the spread pattern remains unchanged and precise, even at varying operational speeds so that the position of the delivery system does not require any adjustment.



Stage 1: Hopper aperture slightly open



Stage 2: Hopper aperture half open



Stage 3: Hopper aperture wide open

TS spreading discs

For the utmost precision at all spreading widths up to 54 m

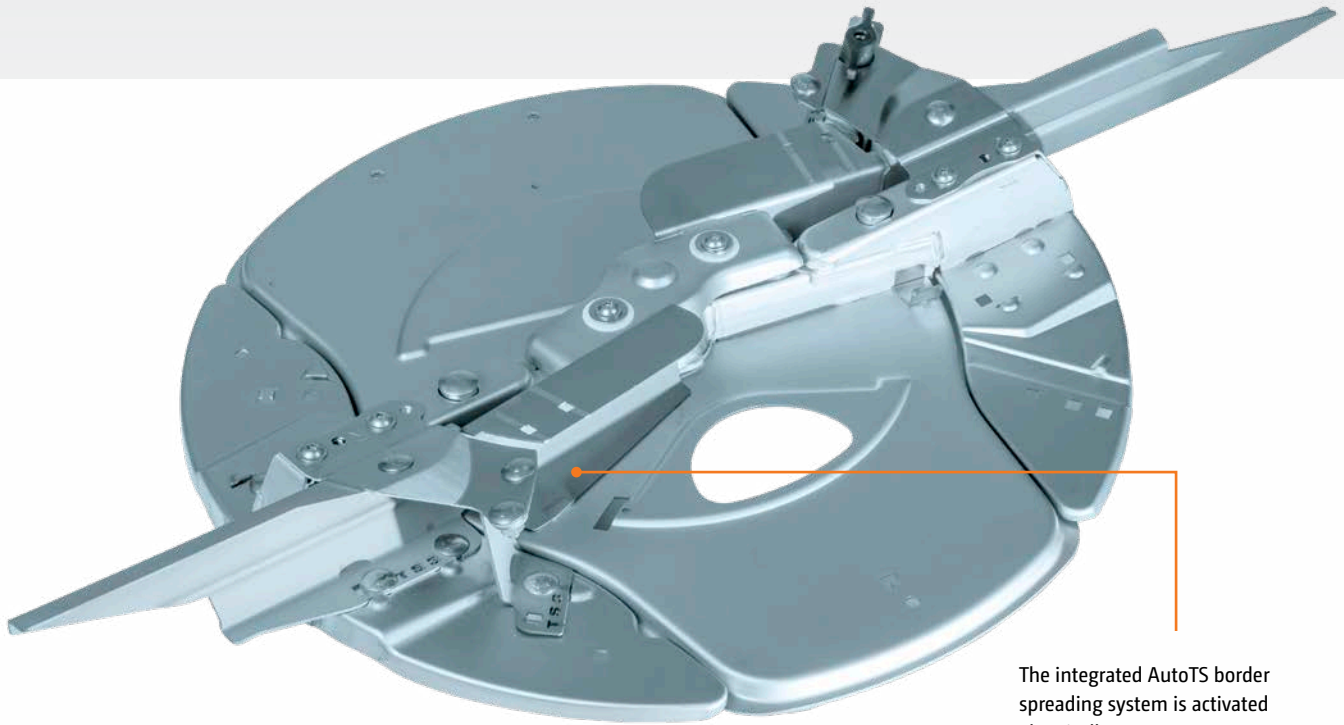

The integrated AutoTS border spreading system is activated electrically.

Spreading system made from stainless steel – For a long service life

On the TS spreaders the entire spreading system is made from stainless steel providing a long service life.

The vane change system enables the quick and easy change of just the spreading vane tips. The ideal solution, for example, for agricultural contractors. Between normal spreading and border spreading, different spreading vanes are activated via the so-called AutoTS system without the necessity to change spreading disc settings.

Hard-coated spreading vane

The spreading vanes are coated with a special long-lasting anti-wear protection. This is made possible by an especially hard structure to the metal. This finish is produced through a high-speed flame heating process that develops an ultra-hard coating to protect the spreading vanes against abrasive wear. Consequently, the result is a three-fold increase in lifespan.

Spreading vane sets

- ✔ TS 1 = 15 m – max. 24 m
- ✔ TS 2 = 21 m – max. 36 m
- ✔ TS 3 = 24 m – max. 54 m

❗ "For different working widths it is then just a case of interchanging the spreading vane set – a very comfortable solution."

(profi – Driving impression ZA-TS 4200 Profis Hydro fertiliser spreader– 06/2013)

Optimised spread pattern



Normal spreading

Via the adjustment of the delivery system, the feed-on point of the spreading material on to the spreading disc is changed and thus the spreading width and the lateral distribution are controlled. In addition, the working width can be set even more individually by changing the disc speed.

Non-sensitive spread pattern via the multi-sectional spread fan

The specific shape and angling of the spreading vanes result in a multi-spread fan from the TS spreader unit. This means that the long and short spreading vanes do not influence the spread pattern to either side and an optimum trajectory is maintained.

Three-dimensional spread pattern

The spreading unit has been developed using three-dimensional spread patterns so that a perfect lateral distribution of up to 54 m working widths is achieved. The large overlap zones ensure a perfect spread pattern and are significantly more consistent with regard to any the external influences such as a side wind, change in topography, humidity and changing fertiliser qualities.

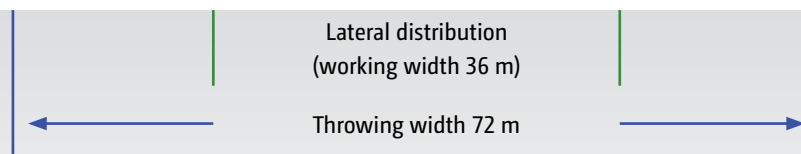
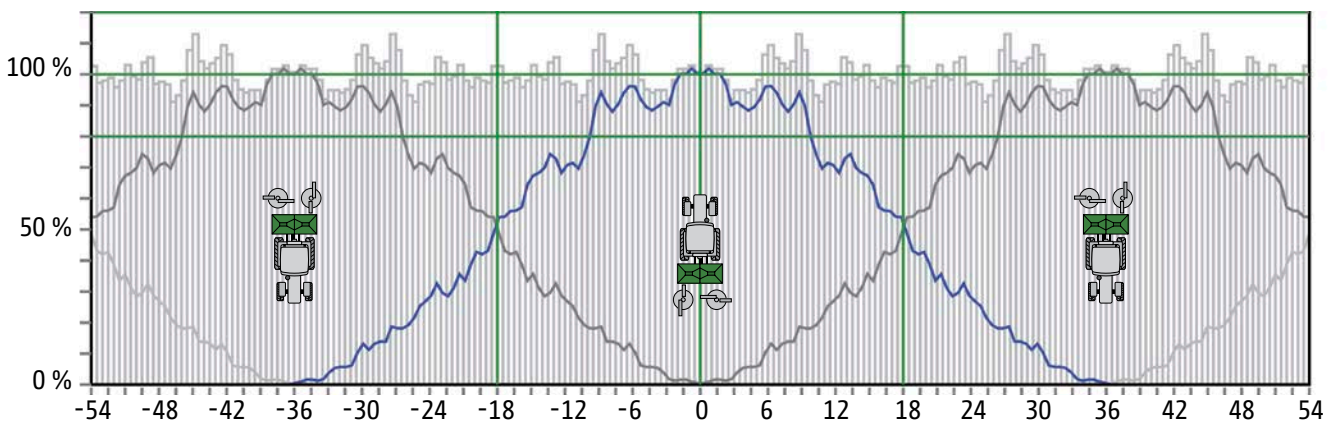
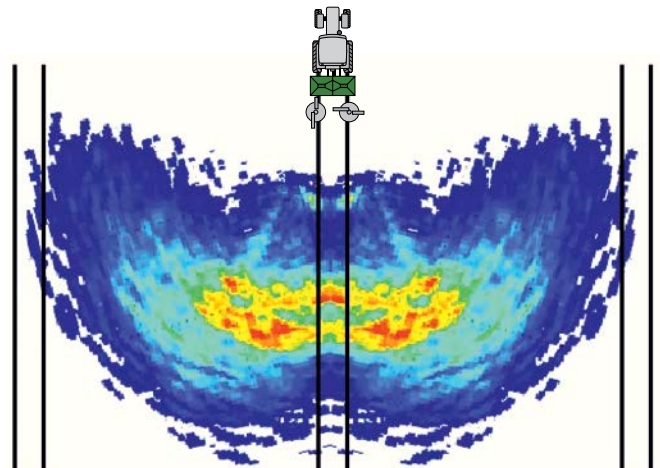

AutoTS border spreading system

Complete control. At any time!



Effective and precise!

Spreading only where the fertiliser is of benefit to your plants

Side spreading (yield oriented setting)

The neighbouring field is an area that is used agriculturally. In this case it is tolerable for a small quantity of fertiliser to be thrown over the border of the field. The fertiliser distribution inside the field boundary is still 80% of the desired application rate at the edge of the field.

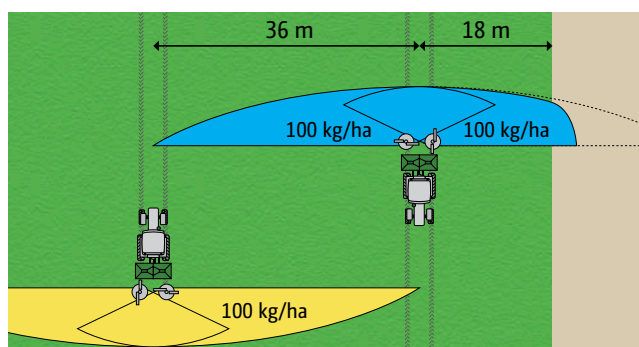

Boundary spreading (environmentally oriented setting)

If the field is adjacent to a road or cycle path, no fertiliser must be thrown beyond the border of the field. The spread rate must be reduced on the border side so that no over-fertilisation occurs within the boundary of the field. A small amount of under-fertilisation occurs up to the edge of the field. The border spreading procedure complies with fertiliser application legislation requirements.

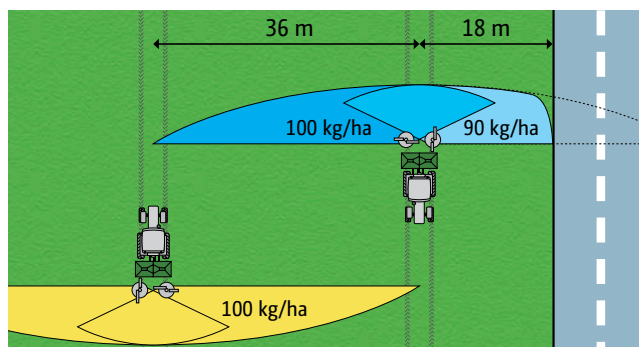

Water course spreading (environmentally oriented setting)

In case of a water course right against the side of the field, the fertiliser decree requires, with a boundary spreading system, a distance of one metre left fertiliser-free around the border and, without a boundary spreading system, as much as three metres. In order to avoid the over-fertilisation inside the field, the spread rate has to be reduced on the field's border.

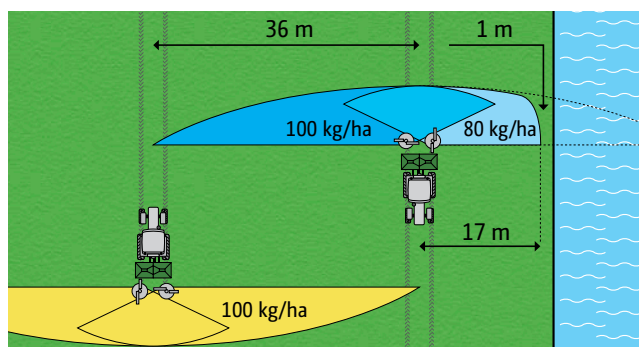

AutoTS

The disc integrated border spreading system

AutoTS – comfortable and precise Lateral distribution right up to the field’s border

The disc-integrated AutoTS border spreading system enables the activation of the different border spreading procedures – side, border or watercourse spreading – comfortably via the Terminal in the tractor cab, irrespective of which side.

AutoTS - the ingenious principle

A setting motor twists the delivery vane forwards by approximately 10 ° so that, when border or watercourse spreading, the fertiliser is delivered via the shorter border spreading vanes. Due to the combination of disc speed and shorter vane, the fertiliser is thrown over a significant shorter distance without affecting it mechanically.



AutoTS – adjustment of the delivery vane for boundary spreading

- ❗ “Where no one needs to climb down to readjust a spreading vane, no one can get injured or make any other mistakes.”
 (“profi” – Spreading units in practice “Hydraulic or mechanical”. 06/2017)



AutoTS – adjustment for normal spreading



AutoTS – adjustment of the delivery vane for boundary spreading

Increased yield on the border thanks to AutoTS

The AutoTS border spreading system provides the user with a very reliably steep border spread pattern and thus optimum growing conditions near to the field edge. Compared to other border spreading systems, a significant increase in yield is possible.

The AutoTS spreading system makes use of an automated rate reduction when boundary spreading with the spread rate setting in freely-selectable percentage steps. As the two spreading discs can be operated independently from one another, the change to one or both sides can be adjusted.

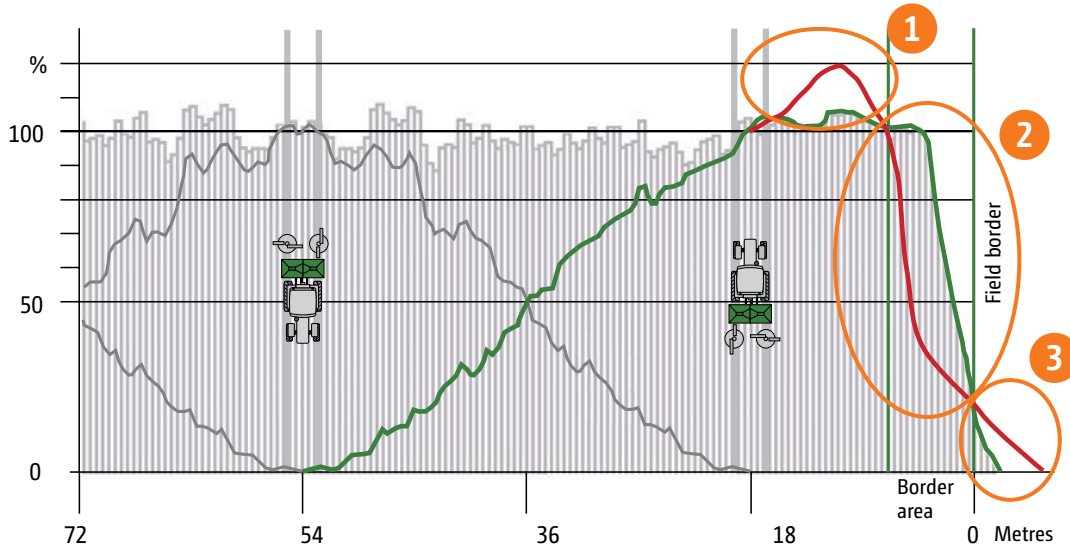

	AutoTS border spreading system	Conventional border spreading systems
1	Due to the shorter spreading vane, the fertiliser is limited in its spreading width.	The mechanical deflection of the fertiliser causes damage to the granules which then drop next to the tramline.
2	The fertiliser is undamaged and optimally distributed right up to the field border.	This amount of damaged fertiliser is then missing from the border area resulting in under-fertilisation.
3	Due to the reduced throwing speed of the fertiliser, only a few granules fall beyond the field edge.	Not all the fertiliser granules are mechanically deflected so that some are clearly spread beyond the field's border.

HeadlandControl

Optimum lateral distribution on the headland

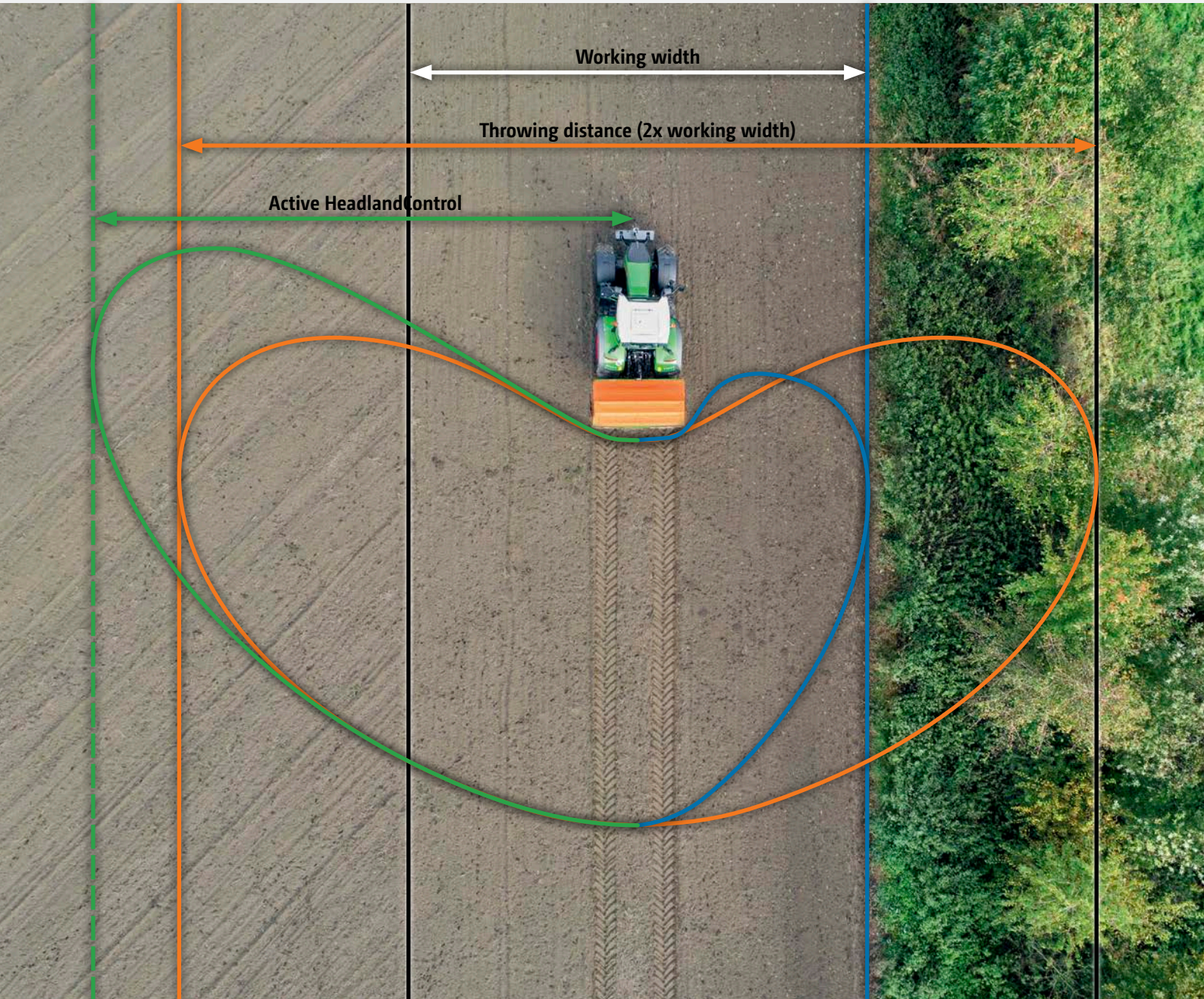

— HeadlandControl — Normal spreading — Border spreading

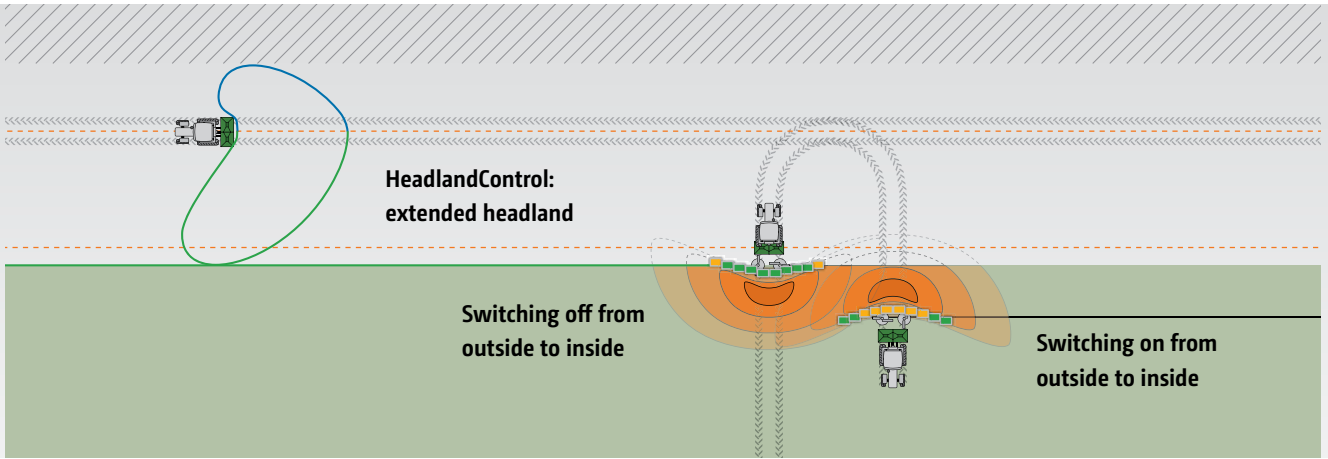

Perfected headland coverage thanks to HeadlandControl and the new part-width section control

The problem: Over- and under-fertilisation on the headland

Different fertilisers have different switch-on and switch-off points. In practice, the switch-off points are usually only achieved when the tractor is turning on the headland. The arc of spread behind the tractor swings round to the side creating areas that are either over- or under-fertilised.

Switch-off time on the headland: Without HeadlandControl

1. Spreader switches off too late and is already turning
2. Tractor would have to drive beyond the headland tramline

Result: Over- and under-fertilised zones are created

The solution: HeadlandControl

When HeadlandControl is activated, the throwing width and spread rate are increased on the inner field side, so that the switch-off point is moved towards the inside of the field. Furthermore, the new part-width section control, which is now adapted to the shape of the spread fan, causes the part-width sections to be switched off from the outside to the inside when entering the headland. Over- and under-fertilised zones on the headland are subsequently avoided.

With HeadlandControl

1. HeadlandControl means that the spreader continues to apply fertiliser to the crop when it is on the headland
2. The tractor can follow the wheel tracks of the sprayer

Result: Uniform crops across the headland

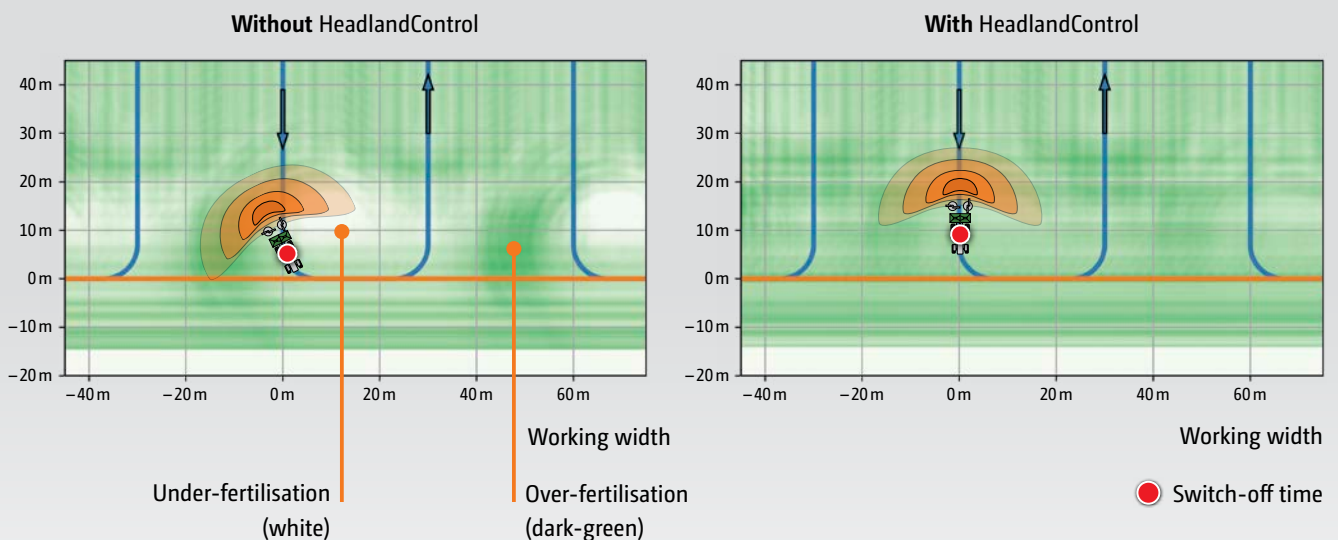

ArgusTwin

The spreader's eyes – it sees what you don't see!



Argus

❗ "ArgusTwin optimised the lateral distribution within seconds."
("profi" – Test report Amazone ArgusTwin · 01/2016)

Automatic adjustment to the optimum lateral distribution

With the Argus Twin system, AMAZONE offers a system for spread pattern monitoring with automatic spread pattern adjustment. The registration of the lateral distribution is carried out via radar technology which is not affected by dust and pollution, and provides reliable results in practice. ArgusTwin constantly monitors, via radar sensors mounted on both the sides of the spreader, the left and right hand spread fans simultaneously and re-adjusts the electric delivery system independently of each other if necessary.

Automatic delivery system adjustment

Via the ISOBUS terminal, the application rate and any further relevant data for the fertiliser to be spread are entered from the setting chart. For the Argus system, the spreading chart has been updated to include the throwing angle that gives the optimum lateral distribution. Utilising this value, ArgusTwin constantly checks whether the predetermined direction of throw for that fertiliser is in fact being maintained by the spreading discs. When the actual throwing width deviates from the “desired” throwing width due to inconsistencies within the fertiliser, worn spreading vanes, working across slopes or during starting and stopping procedures, the spreader readjusts, on its own, the setting for the delivery system – and that of each side individually.

The concept of the fertiliser spreader with ArgusTwin and weighing system

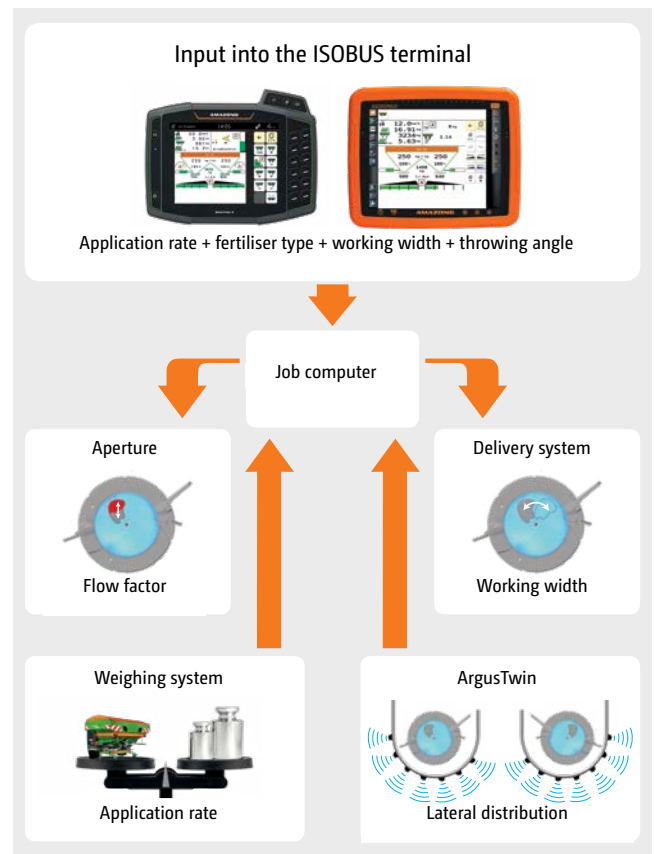

Independent monitoring of both sides of the spread fan via 14 radar sensors

Via the constantly working on-line monitoring and readjustment of the delivery system, the ArgusTwin system ensures an optimum lateral distribution of the fertiliser. This leads to a more effective fertiliser use and forms the basis for optimum crop management.

The system is immediately live and operates even when border spreading and if part-width sections are switched off and on. In hilly terrain, Argus even provides slope compensation of the spread pattern via the automatic readjustment of the delivery position of the fertiliser. Due to the rigid fixing, the system avoids any moving components and is thus extremely robust and is completely maintenance-free.

Top features of ArgusTwin:

- ✔ The system is ready for operation immediately
- ✔ Positioned directly above the spreading discs
 - the system is located safely between the outer guard tube and the base hopper
 - therefore no areas where moisture, dirt or fertiliser may deposit
- ✔ Constant on-line monitoring of both spread fans
- ✔ Maintains an optimum lateral distribution of the fertiliser even with changeable fertiliser quality
 - Basis for optimum crop management
 - More effective use of the fertiliser
- ✔ The system is also active when border spreading or if a part-width section is switched on or off
- ✔ Automatic slope compensation of the spread pattern by readjustment of the delivery system position
- ✔ Rigidly attached to the spreader: no moving parts – completely maintenance-friendly and free of wear



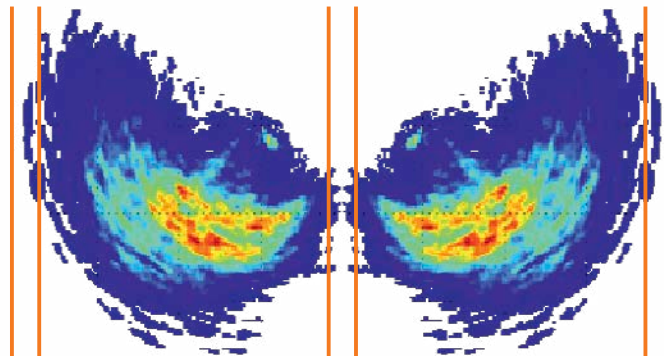

The problem in practice – poor lateral distribution, for instance, due to a change in fertiliser properties

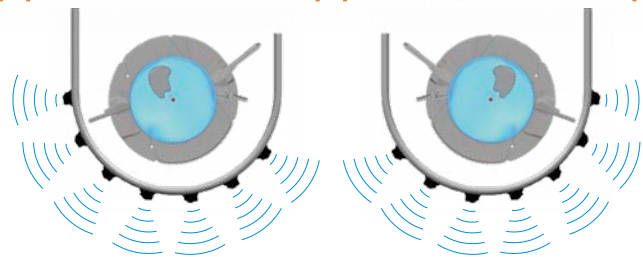

Independent monitoring of both sides of the spread fan via 14 radar sensors



Automatic adjustment of the delivery system via ArgusTwin

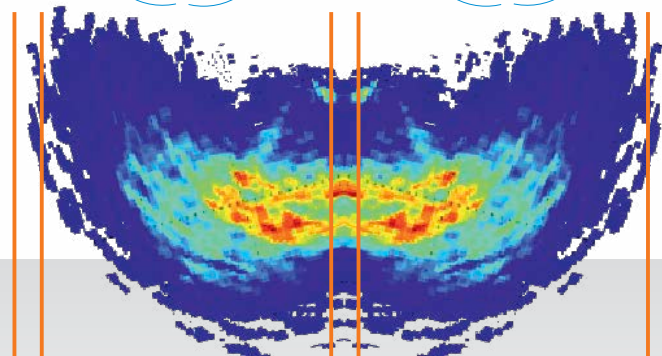
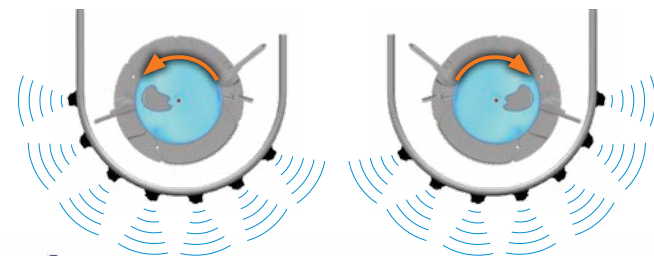

The perfect lateral distribution gives evenly established crops even with changing fertiliser qualities and properties

WindControl

for areas where wind is always a problem

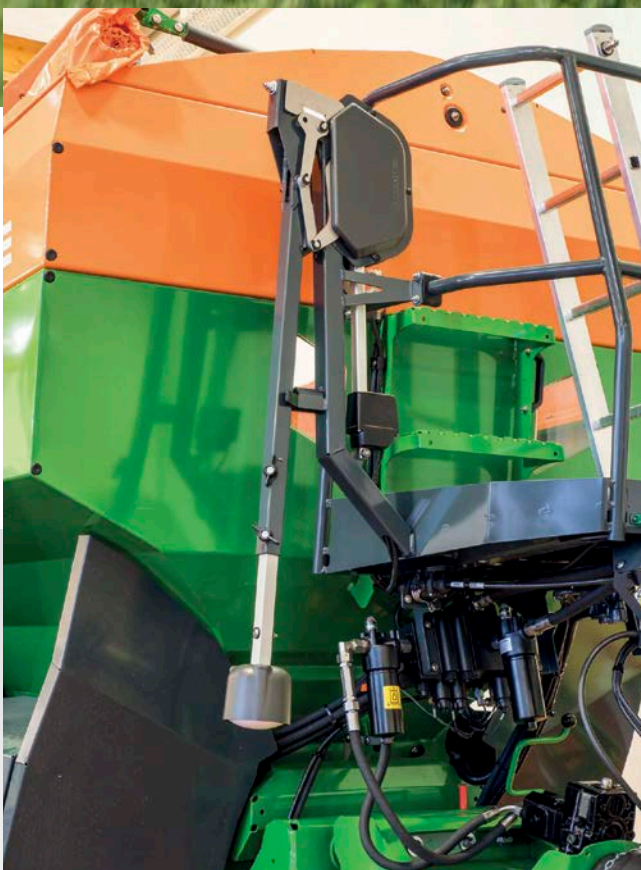

- ✔ As soon as the spreading discs have been deactivated for road transport, WindControl automatically moves into its transport position.



- Both the wind speed and wind direction are displayed in the terminal

Optimal distribution

In areas that are particularly windy, AMAZONE now offers WindControl (in accordance with Prof. Dr. Karl Wild, HTW Dresden) as a supplement to the ArgusTwin system. Via WindControl, the influence of wind on the spread pattern can also be constantly monitored and automatically compensated for.

Mounted on the machine, a high frequency measuring wind sensor, registers both the wind speed and also the direction of wind. According to this data, the job computer then calculates, in conjunction with the information from ArgusTwin, any new settings for the delivery system and the spreading disc speed which are then automatically

acted upon. For side winds, the disc speed to the windward side is increased and the delivery system advanced whereas, at the same time, the disc speed on the leeward side is reduced and the delivery system retarded.

With the aid of WindControl, larger time windows are created for spreading under the influence of wind. Apart from all the important fertiliser spreader parameters, the user additionally always has, in view, the real-time direction of the wind, the force of wind and if the wind is gusting. In addition, in heavy winds, when the system is no longer able to compensate for, or when the wind gusts are too frequent, WindControl sends an automatic alarm to the driver.



Wind sensor

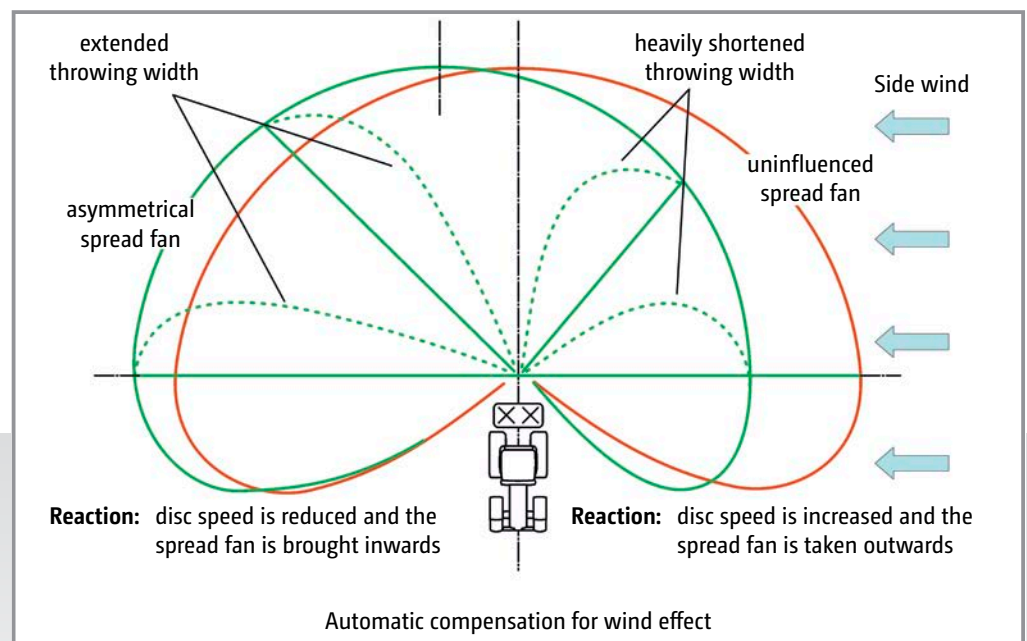

Everything has been thought of!

For more safety in the field and on the road



ZG-TS: more safety in road traffic!

Benefits of SafetySet

- ✔ More safety in road traffic thanks to over-dimensioned axles and brakes
- ✔ Twin-circuit air braking system or hydraulic brakes, both with parking brakes
- ✔ In conjunction with the electronic braking system (EBS) the ZG-TS is, as standard, equipped with an ABS system (anti-lock system)
- ✔ Safely accessed via the retractable ladder
- ✔ Bright lighting systems
- ✔ Spacious platform and safe access to the hopper
- ✔ Mudguards
- ✔ Hand wash tank

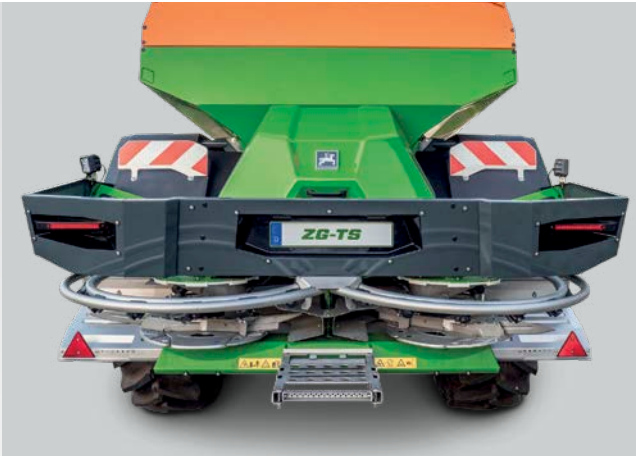

✔ Hydraulic parking jack

SafetySet – integrated as standard More safety for both people and machine

As with all equipment from AMAZONE, the ZG-TS has a very high level of base equipment to ensure the safety requirements are fulfilled correctly. The lighting system with its state of the art technology (LED lights) ensures safe road transport and is, in addition, long-lasting and robust.

Hydraulic parking jack – quick coupling and uncoupling

To enable the coupling and uncoupling of the ZG-TS with as much ease and speed as possible, the ZG-TS trailed spreaders feature, as standard, a hydraulic parking jack. To maintain the high ground clearance, the stand, when folded away practically disappears entirely into the frame.

Linkage – couple up and go!

Make the choice that suits your tractor! The drawbar and coupling system are freely combinable. Decide between a towing eye, a K80 ball coupling, a ring coupling or a

pivoting ring coupling and select between a drawbar hitch coupling and the classic drawbar coupling!



✔ Clevis type coupling with towing eye



✔ Hitch coupling with K80 ball coupling

Equipment

Perfect down to the last detail



Work lights – as bright as day at any time

With the optional work lights, important areas of the spreader can be sufficiently illuminated when operating at night. For monitoring the fill level and for when loading, high capacity LED head lights illuminate the inside of the hopper.

For checking the agitators and for changes in the spread pattern, additional work lights are installed. In addition, work lights are attached to the sides which illuminate the spread pattern at night time and at the same time can be utilised as filling aid.



Work lights inside the hopper

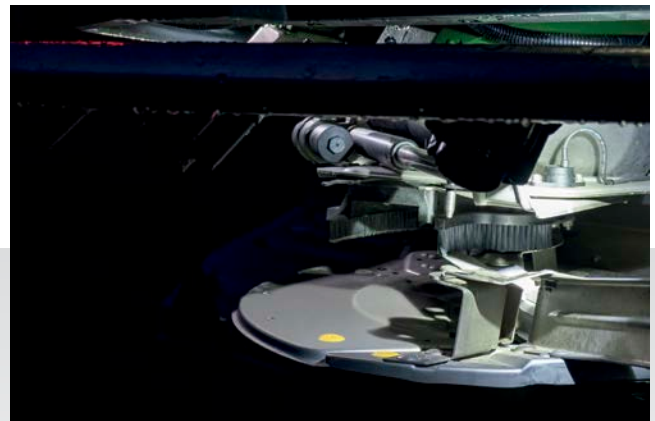

Illuminated spreading disc



❗ “Two transport boxes offer sufficient storage space“
 (“profi“- Test report ZG-TS 01 ProfisPro · 06/2018)

The transport boxes – practical and spacious

Well integrated and within reach, for example, the mobile and digital EasyCheck test set has its place. The very large storage compartments provide the possibility to transport additional spreading vane sets and other tools.

The roll-over hopper cover – comfortable and reliable

Also the hydraulically controlled roll-over hopper cover is especially comfortable. It can be unrolled and retracted comfortably and safely from the tractor cab. Thanks to the clever tensioning mechanism the cover rolls up firmly and tight to the hopper so that no water, dirt or fertiliser can collect there. The cover, when firmly rolled away, also ensures that almost the entire hopper opening can be used without a troublesome rod or a loosely hanging cover getting in the way.



✔ Hydraulically actuated roll-over hopper cover



✔ Hand wash tank – for better cleanliness in the tractor cab

Hand wash tank

As standard, on the left hand side of the machine, a hand wash tank is integrated in the machine so that, even after an interruption, you can wash your hands before continuing to work.

Camera system for ZG-TS – Safety first!

The optionally available camera system mainly serves as a means of ensuring safety when manoeuvring. The high resolution and anti-reflective monitor is backlit and can also display two cameras simultaneously. The coupling to an ISOBUS terminal with an analog video input is also possible.



✔ With the analog video input on AmaTron 4, the picture from the camera can also be displayed alternatively.

ISOBUS –

Machine actuation in the digital age

MEMBER OF



One language, many benefits!

Each ISOBUS-enabled machine from AMAZONE comes with the latest technology and almost unlimited possibilities. It does not matter whether you use an operator terminal by AMAZONE or an ISOBUS terminal directly installed in your tractor. ISOBUS is a worldwide recognised communication standard between, on the one hand, operator terminal, tractor and connected implements and, on the other hand, agricultural office software.

Operation with any ISOBUS terminal

Which means that ISOBUS enables you to take control of all your ISOBUS compatible equipment. You just connect the machine with the relevant ISOBUS terminal and immediately the normal operator interface is displayed on the monitor screen in your tractor cab.

Benefits of ISOBUS:

- ✔ This worldwide standard provides a uniform interface and data exchange formats that ensure the compatibility even with third party manufacturers
- ✔ Plug and Play between machine, tractor and additional ISOBUS implements



AMAZONE – more than just ISOBUS

Improved control, more yield! Precision Farming 4.0

Our competence in electronics

To increase the operational comfort, AMAZONE implements and operator terminals feature a scope of functionality way beyond ISOBUS standards.

The benefits of more than just ISOBUS:

- ✔ Highest compatibility and safety functionality of your ISOBUS equipment
- ✔ No additional modules on the machine side. All ISOBUS machinery from AMAZONE is already equipped as standard with the necessary ISOBUS functions
- ✔ MiniView display with all AMAZONE terminals and additional ISOBUS terminals. See, for instance, the machine data in the GPS view
- ✔ The possibility using the tractor terminal or in a twin terminal solution to separate the functionalities of tractor and connected implement
- ✔ Unique operation concept. Freely-configurable displays and individual user interfaces in the operator terminal
- ✔ Up to 3 user profiles are possible. Establish for every driver or operation an individual user profile!
- ✔ Freely-configurable machine operation as, for instance, the folding procedure of the booms of your AMAZONE crop protection sprayer
- ✔ Tractor ECU function evaluation
Automated movement sequences such as automated blocking of the steering axle while reversing
- ✔ Integrated TaskController data logger. As a matter of principle, every ISOBUS telemetry solution is possible (for example, TONI telemetry from CLAAS).
- ✔ Freely-configurable part-width sections



Make the most of the possibilities

Job management and documentation

All standard ISOBUS terminals from AMAZONE can collect and save machine and site-specific data using Task Controller. The collected data can subsequently be used in your Farm Management Information System.

- ✔ Easily compile or load jobs
- ✔ Processing jobs
- ✔ Document and export the work performed
- ✔ Processing of application maps in an ISO-XML format

GPS-Track

The GPS-Track parallel tracking aid makes orientation in the field much easier, particularly on grassland or in areas without tramline tracks. It has various track modes such as A-B Line and contour lines. Deviation from the ideal track is graphically shown on the display by an integrated light bar. Thanks to the clear steering recommendations with exact tramline distances you always remain on track!

- ✔ The virtual light bar in the status bar
- ✔ is standard for AmaPad 2
- ✔ and optional for the AmaTron 4

GPS-Track – your parallel driving aid in the field

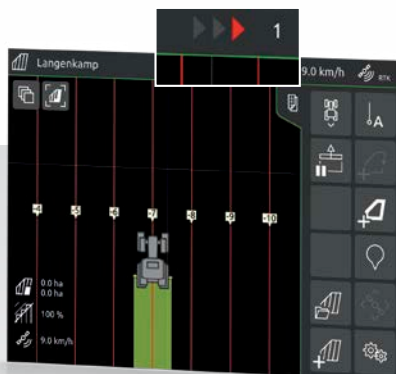

GPS-Maps

GPS-Maps enables uncomplicated part-area site specific management because this software module provides easy use of application maps in a shape file format. Either the target amount of the material to be applied or the target amount of effective ingredient can be directly processed.

- ✔ Intuitive system for working from application maps
- ✔ Automatic part-area site specific regulation of the application rate
- ✔ Optimum crop management via need-oriented application
- ✔ Standard on AmaTron 4 and AmaPad 2



GPS-Maps – part-area, site specific application



agrirouter -

The independent data hub for agriculture



Simple and safe data exchange

agrirouter can work with products and services from different manufacturers and facilitates universal data exchange for AMAZONE. agrirouter provides a safe and easy way to exchange data between AMAZONE machines, agricultural software, manufacturers and companies.

Full control -- choose for yourself!

agrirouter simplifies data exchange by allowing wireless exchange of job data and application maps between AMAZONE machinery. It simplifies operating procedures, reduces administrative effort and improves profitability. You retain control of the data and decide who gets which data and to what extent.

Advantages of agrirouter:

- ✔ Simple and easy handling
- ✔ Comfortable and fast transfer
- ✔ Full control of your data
- ✔ Data are transferred, not stored
- ✔ Manufacturer-independent use

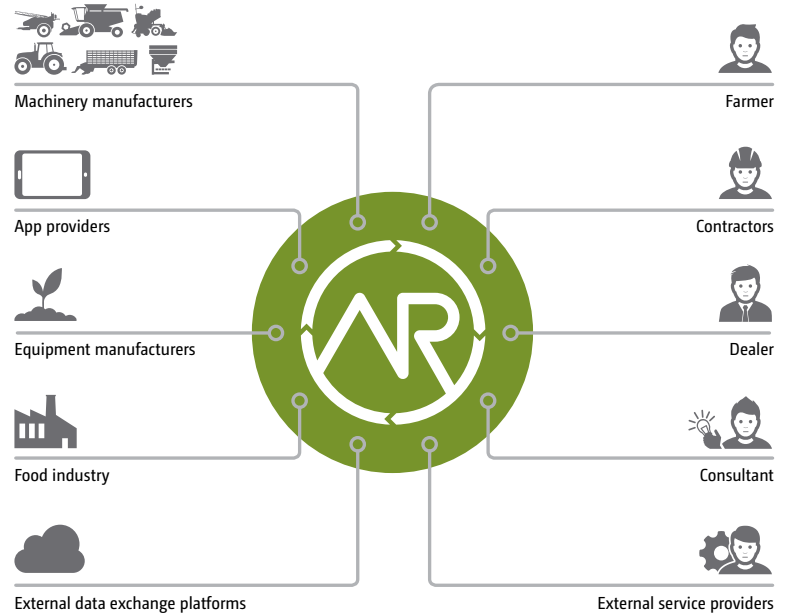

Source: DKE-Data GmbH & Co. KG



AMAZONE implements the connection to ISOBUS machine by using the AmaTron 4

Automatic GPS-Switch part-area shut-off with Section Control

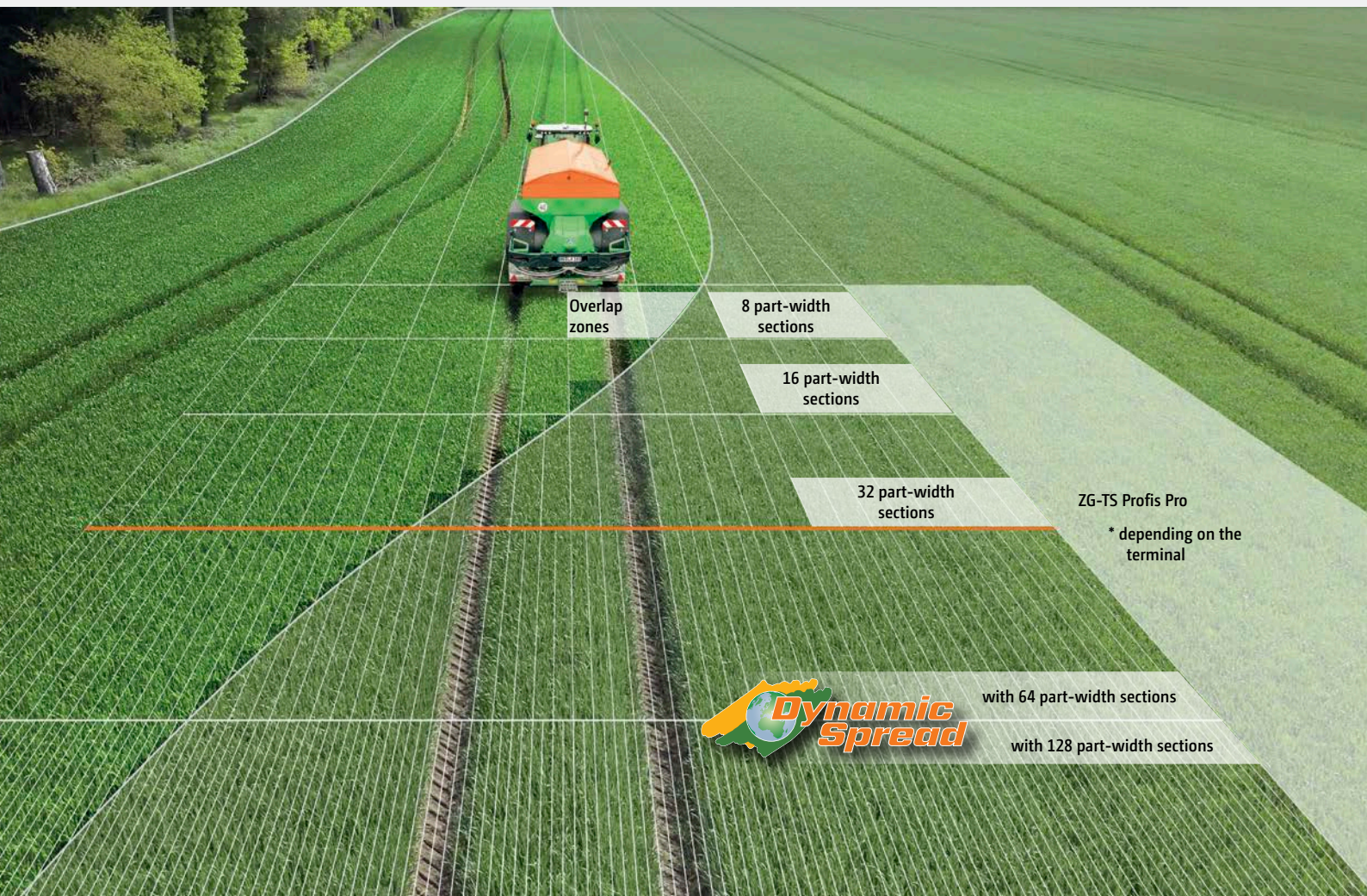

✔ With DynamicSpread, individual outlying part-width sections can also be controlled.

More precision, more efficiency!

In view of the very large working widths used now, the matching of the spread patterns is very important. Thanks to the electric delivery system adjustment on the TS spreading system, it is able to react precisely and sensitively in these cases. So even outer part-width sections can be easily controlled. In addition, due to the individual speed adjustment of the left and right hand side discs, the spreading width can be reduced from the far outside

to the centre, so that, even at large working widths, long and shallow-shaped wedges and short work are optimally spread. This means part-width section control. At the simplest level of specification, 8 part-width sections can be easily actuated manually (via the operator terminal). When utilising a relevant Section Control licence on the terminal, a part-width section control of up to a maximum of 128 part width sections can be utilised.

Functions of an ISOBUS fertiliser spreader	ZG-TS Profis Pro
Spread rate regulation	✓
Setting the delivery system	✓
Matching the spreading disc speed	✓
Number of part-width sections	8 in manual mode
<ul style="list-style-type: none"> • Manual mode via key pressure • Automatic mode via SectionControl/GPS-Switch 	up to 128 in automatic mode
Possible working widths	15–54 m

Automatic part-width section control

If the terminal to be operated features Section Control, such as, for example, GPS-Switch part-width section control from AMAZONE, the switching of the part-width sections can be carried out completely automatically and in relation to the GPS position. Once a field has been established by the driver, then, in the automatic mode, they can fully concentrate on handling the vehicle whilst the switching of the part-width sections in wedges and on the headland is carried out automatically.

Benefits of automatic part-width section control:

- ✓ Stress relief on the driver
- ✓ Increase in precision especially at night or at higher speeds
- ✓ Less overlaps and gaps
- ✓ Saving of resources
- ✓ Less crop damage and environmental pollution

❗ “With Section Control, the ISOBUS computer relieves the driver from a lot of work.”

(“dlz agrar magazine” – “Test report ZA-TS fertiliser spreader”. 02/2017)

GPS-Switch

With GPS-Switch, AMAZONE offers a GPS-based, fully automatic, part-width section control for all AMAZONE operator terminals and ISOBUS compatible fertiliser spreaders, crop protection sprayers or seed drills.

GPS-Switch basic

- ✓ Automatic part-width section control of up to 16 part-width sections
- ✓ Optional for AmaTron 4

GPS-Switch pro

- ✓ Automatic part-width section control of up to 128 part-width sections
- ✓ Creation of a virtual headland
- ✓ Creation of Point of Interests (POI)
- ✓ Automated boom lowering for an AMAZONE sprayer
- ✓ Standard for AmaPad 2
- ✓ Optional for AmaTron 4

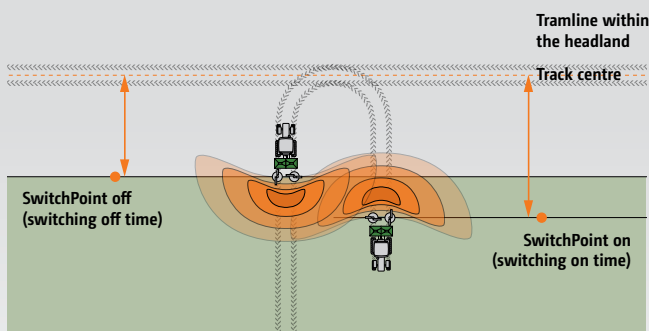

SwitchPoint

SwitchPoint allows, when utilising GPS-Switch, to re-adjust the on/off switching points depending on the fertiliser type and the working width. Both values can be taken from the setting chart and entered into the relevant operator terminal.

ISOBUS terminals from Amazone

Intuitive, comfortable, better – workday made easy

From simple to high-tech – everything is possible

AMAZONE offers two particularly convenient operator terminals for your ISOBUS machinery in the form of the ISOBUS-compliant AmaTron 4 and the AmaPad 2. In addition to pure machine operation, there are additional application options, such as automated GPS-Switch part-width section control.

- ✔ All applications come pre-installed and can be initially tested free of charge
- ✔ Intuitive and clear actuation

Everything in view with the 2-terminal solution

As well as operating the AMAZONE ISOBUS machine through the tractor terminal, there is also the handy alternative of separating the functionalities of the tractor and the attached machine and operating them by using two terminals. The tractor terminal can continue to control the tractor or also display the GPS applications whereas the additional operator terminal in its UT display mode is fully utilised to monitor and control the machine.



Terminal	AmaTron 4	AmaPad 2
Display	8 inch, multi-touch colour display	12.1 inch, multi-touch-colour display
Mode of operation	Touch and 12 soft keys	Touch
Interfaces	1 x Ethernet 2 x RS232 (GPS & ASD) 2x USB interfaces	1 x Ethernet 2 x RS232 (GPS & ASD) 2x USB interfaces with WLAN dongle
Job management and processing of application maps (ISO-XML and Shape)	GPS-Maps&Doc * with integrated Task Controller	Task Controller
Parallel driving aid	GPS-Track * with virtual light bar	GPS-Track pro with virtual light bar
Automatic track following	–	GPS-Track Auto for the Pantera self-propelled crop protection sprayer
Automatic part-width section control (SectionControl) Note: dependent on the max. no. of sections of the machine!	GPS-Switch basic * with up to 16 part-width sections or GPS-Switch pro * with up to 128 part width sections	GPS-Switch pro with up to 128 part width sections
Camera connectivity	1x camera connection * with AmaCam automatic reversing detection	2x camera connections *

* = optional



Everything from a single source!

Thanks to the AUX-N feature, you can operate multiple functions of the machine via AmaPilot+ or any other ISOBUS multi-function joystick.



The benefits of AmaPilot+:

- ✔ Perfect ergonomics
- ✔ Almost every function directly controlled via 3 levels
- ✔ Adjustable
- ✔ Freely-programmable, individual key layout
- ❗ "The joystick rests comfortably in the hand."
("dlz agrar magazine" – "Test report Pantera 450Z" · 02/2016)



- ❗ "The ISOBUS control is an in-house development from AMAZONE and has been designed clearly and is easily understandable. If desired, some keys can be freely allocated. Also the multi-function display can be freely selected."
("agrarteute" magazine – "Test report Centaya seed drill" · 06/2018)

AmaTron 4

Manager 4 all



Easy and comfortable operation as intuitive as your tablet

Why not handle a terminal as intuitively like a tablet or a smartphone? With this in mind AMAZONE has developed the highly intuitive and operator-friendly AmaTron 4 which offers a noticeably smoother operational process, especially when it comes to job management. The AmaTron 4, with its 8" multi-touch colour display meets the highest expectations and offers maximum user-friendliness. A swipe of the finger or using the App carousel allows quick changes between applications and the simple and clearly structured operating menu. A useful MiniView, a freely configurable status line as well as a virtual light bar make the use of the AmaTron 4 particularly clear and convenient.

Benefits of AmaTron 4:

- ✔ Automated full image mode during non-operation
- ✔ Practical MiniView concept
- ✔ Operation via the touch display or via soft keys
- ✔ Especially intuitive and user-friendly
- ✔ Field-related documentation
- ✔ Practice-oriented and intelligent menu guidance
- ✔ Day-night mode

Standard with:

GPS-Maps&Doc



- ✔ Automated AmaCam reverse driving recognition that gives direct access to a reversing camera and prevents dangerous situations

- ✔ Machine operation (UT, Universal Terminal) in day-night mode

AmaPad 2

The especially comfortable way to control agricultural machinery



The new dimension of control and monitoring

AmaPad 2 from AMAZONE is a particularly high-quality operator terminal. The 12.1" multi-touch colour display is particularly comfortable and fulfils the highest demands on Precision Farming. The operation of AmaPad is carried out solely via touch.

With the practical "MiniView concept", applications which aren't being actively operated at that moment but need to be monitored are clearly displayed at the side. When needed these can be enlarged via "a finger swipe". The possibility to individualise a "dashboard panel" with the displays of choice rounds up the user ergonomics.

In addition to the GPS-Switch pro part-width section control, GPS-Track pro, a high-end parallel tracking aid with virtual light bar is included in the standard specification.

Benefits of AmaPad:

- ✔ Large 12.1" multi-touch colour display
- ✔ Extended MiniView concept
- ✔ Upgrade to automatic steering is possible thanks to the automatic GPS-Track Auto track guidance
- ✔ Day-night mode

Standard with:

GPS-Maps pro
GPS-Track pro
GPS-Switch pro



The universal genius ZG-B trailed spreaders



The advantages at a glance:

- ⊕ The robust universal twin disc spreading unit with oil immersed gearbox and overload safety device allows the application of mineral fertiliser, lime or other earth-moist fertilisers
- ⊕ Rigid and robust chassis technology, designed for speeds of up to 50 km/h
- ⊕ Large ground clearance and oversized tyres allow operation even under the most difficult of conditions
- ⊕ Spacious hopper, 5500 litres and 8200 litres; saving on transport and loading times
- ⊕ The large fill opening ensures easy filling procedures from bulk silos or with a front-end loader
- ⊕ The steep hopper walls ensure the consistent flow of the spreading material even in sloping terrain
- ⊕ Low-wear rubber floor belt with automatic floor belt centring
- ⊕ Compact, safe closing and operator-friendly swivel hopper cover
- ⊕ FertiliserService, high class and unique service with over 25 years experience

5,500 or 8,200 litres
hopper capacities

Up to **50 km/h**
transport speed

Up to **36 m** working width



**AMAZONE spreaders
fulfil all European
environmental
standards**



MORE INFORMATION
www.amazone.net/zg-b

ZG-B bulk fertiliser spreaders

With universal spreading unit for fertiliser and lime



ZG-B Super 8200

With the ZG-B hopper volumes of 5,500 l and 8,200 l, AMAZONE introduces high capacity trailed spreaders for the economic and ecologic application of mineral fertilisers and earth-moist fertilisers. Thanks to their reliability and easy handling, the ZG-B's are perfectly suited for operation on large farms, with contractors or in farm overlapping situations. Various specification options and a comprehensive range of special equipment make the ZG-B the individual all-rounder for all fertiliser tasks.

Running gear – high levels of comfort for maximum work rates

- ✔ Well-engineered and robust running gear designed for speeds up to 50 km/h
- ✔ Over-size tyres reduce ground contact pressure and enable the spreader to be used in even the harshest of conditions
- ✔ 7.0 to 9.8 t payload
- ✔ Track widths of 1.50 to 2.25 m are possible for tyres with an AS profile
- ✔ Increased driving comfort due to spring-suspended and height-adjustable drawbar systems
- ✔ Increased safety in road traffic due to large-dimensioned axles and brakes (Twin-circuit air braking system or hydraulic braking system)
- ✔ High ground clearance

Further optional benefits:

- ✔ Remote-control of side and boundary spreading possible
 - ✔ Precise fertiliser metering using state-of-the-art weighing systems
 - ✔ Comfortable operation via the operator terminal (for ZG-B Drive)
- ✔ Standard comfort: The automatic rubber belt floor control guarantees constant conveyor centring, even under demanding conditions.

Large-capacity hopper – saves travelling and loading time

- ✔ Easy to fill from the store or using a loader thanks to large filling opening
- ✔ Steep hopper walls ensure a consistent flow of spreading material even on sloping terrain
- ✔ Low-wear rubber floor belt with automatic floor belt control

Sophisticated technology – first-class spreading results

- ✔ Stainless steel sheet metal withstands even intense abrasion from fertilisers
- ✔ Mechanical spreading disc drive available for PTO shafts speeds of 540 rpm, 720 rpm or 1,000 rpm
- ✔ Maintenance-free and robust oil-bath gearbox with integrated overload safety



ZG-B Special and ZG-B Super –

Cutting costs with high performance!



ZG-B Special

- ✔ Mechanical spreading disc drive
- ✔ Floor belt drive via PTO shaft
- ✔ Hopper volume 5,500 / 8,200 l
- ✔ Working widths 10–36 m



ZG-B Super

- ✔ Mechanical spreading disc drive
- ✔ Belt floor drive via ground wheel (forward speed-related application rate regulation)
- ✔ Hopper volume 5,500 / 8,200 l
- ✔ Working widths 10–36 m

- ✔ The ZG-B Super features forward-speed related rate control via ground wheel drive. The ground wheel drive ensures that the spread rate remains constant even at different forward speeds.
- ✔ Via the gearbox (ZG-B Special / ZG-B Super) there is a choice between two floor belt speeds for metering either large or small application rates.



Robust and reliable

The robust ZG-B Special and ZG-B Super bulk fertiliser spreaders are top of the class when it comes to cost-effective fertilising. They are equipped with a strong universal lime spreading unit for working widths of up to 15 metres. This enables even large quantities to be evenly and accurately distributed.

Versatile application

In addition, the ZG-B Special and ZG-B Super bulk material spreaders can also be equipped with the OM spreading discs allowing the spreading of mineral fertiliser at working widths of up to 36 m. The exchange of the spreading discs is simply and quickly done.



Stainless steel rate sluice gate for setting the spread rate with an easily readable scale directly in the operator's field of vision, and easily adjustable.

Option: hydraulic operation and half-side shut-off with the double shutter slide system.

The rugged universal twin-disc spreading unit with oil-bath gearbox and overload safety for direct driving of the spreading discs ensures an even distribution, even with very high spread rates.

Also available as an option: OM spreading discs for the application of granular mineral fertilizer.

ZG-B Drive –

the all-rounder for successful seamless spreading



ZG-B Drive

- ✔ Mechanical spreading disc drive
- ✔ Electro-hydraulic drive of the floor belt (forward speed-related application rate regulation)
- ✔ Part-area, site specific spreading via application maps
- ✔ Hopper volume 5,500/8,200 l
- ✔ Working widths 10–36 m

The all-rounder

The ZG-B drive is a real all-rounder. It can be used equally for spreading both earth moist lime and granulated mineral fertiliser for base fertilisation. The ZG-B drive ensures reliable and precise work under all conditions.

AmaTron 3 and the optional weighing system for the ZG-B Drive are of special benefit to agricultural contractors.

With this level of equipment, the actual applied spread rate can be determined and adjusted on the move if necessary. This guarantees a consistent application rate and is the best way to ensure an even nutrient distribution. A further plus: the weighing system is utilised by the automatic plot related documentation (ASD).

- ✔ The stepless spread rate regulation can be used for stationary emptying



Operation via a terminal –

AmaBus with AmaTron 3 for ZG-B Drive

Cost saving and environmentally-friendly!

When equipped with the AmaBus electronics, the ZG-B Drive can also be comfortably controlled and monitored via the AmaTron 3. The bright, easy to read, display provides an excellent view of all information. AmaTron 3 boasts a clear, simple and logical layout. In addition, AmaTron 3 can be used for manual section control and accurate application, thanks to the forward speed-dependent spread rate regulation.



- ✔ AmaTron 3 is machine overlapping across all AMAZONE fertiliser spreaders, sprayers and seed drills

Benefits of the ZG-B Drive

- ✔ Low wheel slip for exact speed recording via wheel sensor
- ✔ Simple and freely selectable metering of the spread rate via the shutter slide
- ✔ Comfortable operation and control via AmaTron 3
- ✔ Forward speed-related spread rate regulation via electro-hydraulically controlled rubber floor belt
- ✔ Universal twin-disc spreading unit with lime spreading discs
- ✔ Optional: Limiter border spreading device
- ✔ Standard half-side shut off reduces over-fertilisation when base fertilising
- ✔ Simple emptying of residues when stationary using hydraulic belt floor drive
- ✔ Optional weighing system



AMAZONE spreading technology – absolute accuracy



Exact: the OM spreading discs with adjustable spreading vanes provide a spread pattern of utmost precision.

Simple: the working width and spread rate can be set simply using spreading vanes and metering shutters, and without the use of tools.

Durable: OM spreading discs are made completely of high-grade stainless steel and are simple to install.

Extra: with OM spreading discs, you also have the ideal equipment for late top dressing: simply fold up the swivel blades supplied as standard on the spreading vanes.



OM spreading discs for ZG-B:

OM 10-16

OM 18-24

OM 24-36 (with hard-faced coating for a long service life)

Keeping it green! –

AMAZONE Limiter border spreading system

Limiter made from stainless steel

Side and boundary spreading are among the most important aspects of fertiliser spreading. The AMAZONE Limiter enables precise application of fertiliser right up to the edge of the field. It ensures optimal distribution and excludes over-spreading in areas that are not used for agricultural purposes. This is not only particularly economical, but also provides active environmental protection. The hydraulically-actuated Limiter is controlled comfortably and directly from the tractor seat.

The Limiter can be moved on a fixed frame within a generously dimensioned swivel range. This enables easy adjustment according to the function required (working width, side or boundary spreading, type of fertiliser).

The benefits:

- ✔ Non-stop spreading
- ✔ No interruption of work
- ✔ No climbing down from the tractor

Limiter in action

The Limiter is swung down into the spread fan. The lamellar block creates a change of direction for part of the fertiliser fan.

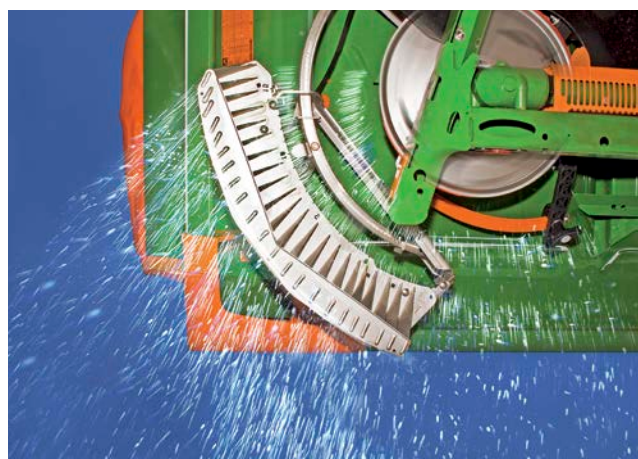

The result:
an optimal spread fan along the boundary.



Limiter border spreading system in working position



Limiter border spreading system raised out of work

Additional options also available



The swivelable hopper cover protects the fertiliser against mud and rain.



Hydraulic shutters enable you to switch off each side individually, e.g. base fertilising. For spreading earth moist lime, dried chicken manure, dehydrated sewage sludge, etc., you can simply wind up the shutter and if necessary, lower the chain rake.



Specialist equipment: Spreading disc for bone meal complete with chain rake for an even material flow.



The large hopper capacity means that filling times are reduced to a minimum. This enables a significant increase in the area output per working hour.



With the calibration kit, the flow rate of the fertiliser is checked. This means that the application rate can be accurately determined.



Via the weighing system, the hopper fill level of your and the application rate is always in view. For the ZG-B Drive, the spreader can also be calibrated while stationary.



40 km/h approved:
Large warning signs and robust mudguards.



Plastic transport box offers a convenient way to transport the mobile test rig.



Robust funnel chute – for the use with granulated fertilisers in conjunction with the OM spreading discs (ZG-B Special, ZG-B Super, ZG-B Drive).



The reversing camera offers additional safety when manoeuvring about the yard or in the field. The camera also offers night vision and a heated lens for maximum visibility.



Weighing display without regulation for monitoring the hopper contents (only for ZG-B Special & ZG-B Super). The maximum transport speed in combination with the weighing system is limited to 40 km/h.



Large protective sieves – the spreading system is optimally protected from stones or other foreign objects.

ZG-TS Truck & ZG-B Truck

High efficiency between yard and field



 With the ProfisPro unique weighing technology



✔ ZG-TS Truck in work



✔ ZG-B Truck in work

More efficiency thanks to high transport speeds

The ZG-TS and ZG-B trailed spreaders are the ideal solution for contractors and farms which have to travel large distances between field and yard. By utilising the ZG-TS and the ZG-B on a carrying vehicle even large transport distances can be managed, significantly quicker and with less fuel consumption. In addition, the spreaders on carrying vehicles can be used with larger ground clearances and track widths so that the range of application is increased. As with the standard ZG-TS, truck mounted spreaders are delivered with the ProfisPro on-line weighing system, it sets new standards in this area of application.

Advantages of the ZG-TS Truck / ZG-B Truck

- ✔ Better manoeuvrability in the yard and in the field
- ✔ More efficiency on the road thanks to higher transport speeds
- ✔ Benefits of the carrying vehicle, such as, larger ground clearance and track widths

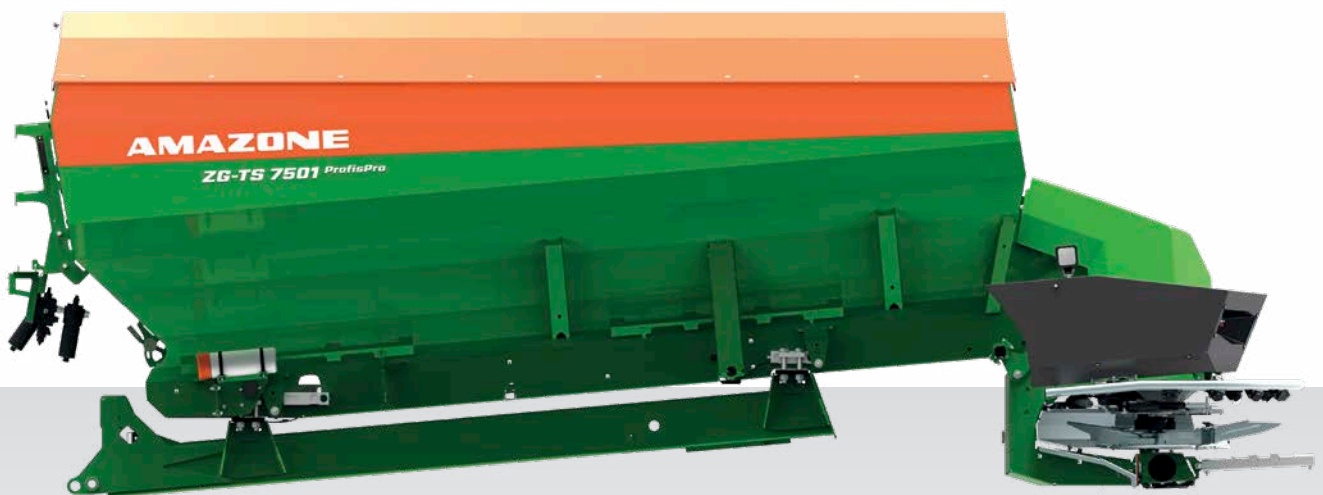

✔ Optimum weight distribution due to the hopper inclined forward

AMAZONE Service – always in the vicinity

Your satisfaction is our challenge



AMAZONE SmartService 4.0

Due to the increasing use of evermore complex machine technology, AMAZONE utilises, with the SmartService 4.0, both virtual and augmented reality as well as digital media for service, training and maintenance advice.

- 1 **SmartTraining:** training and instruction in the use of complex machinery by using the Virtual Reality technology (VR).
- 2 **SmartLearning:** interactive driver's training for the user for complex machinery operation (www.amazone.de).
- 3 **SmartInstruction:** repair or maintenance instructions using Augmented Reality (AR) and mobile terminal equipment
- 4 **SmartSupport:** direct local support from the service technician via Augmented Reality (AR) and mobile terminal equipment



The satisfaction of our customers is the most important objective

For this we rely on our competent sales partners. Also for service queries, they are the reliable contact for farmers and agricultural contractors. Due to continuous training, our sales partners and service technicians are always up to date when it comes to looking after this state of the art technology.

We provide you with a first-class spareparts service

Our global spare parts logistics is based at our central spare parts warehouse in Leeden. This ensures the optimum availability of spareparts, even for older machines.

Parts, are available in our central spareparts store in Leeden and which have been ordered up until 17 hours, are dispatched the same day. 40,000 different line items of spare parts and wear parts are commissioned and stored in our highly modern warehousing system. Daily, up to 800 orders are dispatched to our customers.

Better to choose the original, right from the beginning

Your equipment is exposed to the most arduous of demands. The quality of AMAZONE spareparts and wearing metal offers you the reliability and safety you need for efficient soil tillage, precise sowing, professional fertilisation and successful crop protection.

Only original spareparts and wearing metal is perfectly matched to AMAZONE machinery in their functionality and durability. This ensures the optimum operational performance. Original parts at a fair price pay off in the end.

Therefore, make your decision the original!

The advantages of original spareparts and wearing metal

- ✔ Quality and reliability
- ✔ Innovation and efficiency
- ✔ Immediate availability
- ✔ High resale value of the used machine

AMAZONE "SmartLearning" – the new way of driver training via a PC

Via the Internet "SmartLearning" portal, AMAZONE has extended its service offering on its homepage www.amazone.de/smartlearning with a very useful function. "SmartLearning" offers interactive driver training, which enables the driver to practice the operation of complex machinery on his own, both online and offline, via a PC or tablet. The new service offers drivers the possibility to get acquainted with a new machine prior to its initial operation. However, experienced drivers can also refresh their knowledge enabling them to utilise better still the full potential of their machinery.



Spreader Application Centre

Exemplary advice – for more than 25 years

The settings are crucial!

With the Spreader Application Centre, AMAZONE offer even better customer service. In addition to the already well-established fertiliser laboratory and spreading hall, the Spreader Application Centre now also includes the areas of “Test and Training”, “Data management” and the relevant “Knowledge transfer”.

The two last areas are accompanied by a reorganisation that caters for the increasing globalisation and digitalisation of agriculture. The aim of the Spreader Application Centre is to offer to the customer an even better service with regard to fertiliser application.



Fertiliser laboratory



Spreading hall



Test and Training

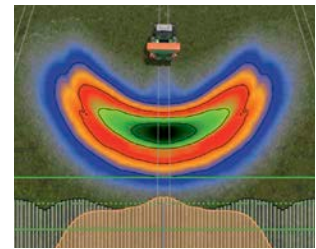

Data management and knowledge transfer

FertiliserService – You can contact us via:

The FertiliserService works beyond limits. Because no matter whether your fertiliser spreader is 5 or 50 years old, we are always by your side with competent and reliable assistance.

Internet: www.amazone.de
 ✉ E-Mail: duengeservice@amazone.de
 ☎ Telephone: +49 (0)5405 501-111
 📞 WhatsApp: +49 (0)175-488 9573

Also available via an App for iPhone and other Smartphones.



Android equipment



iOS equipment

Only when properly spread is your fertiliser worth its weight in gold

The AMAZONE FertiliserService closely cooperates with well-known manufacturers of spreading material – worldwide to be able to make available to you the best setting values as quickly as possible. AMAZONE is the name for precise spreading charts, worldwide.

📌 "Depending on the area applied, a theoretical gain of 100 to 1,000 euros per hour can be achieved with a perfectly adjusted fertiliser spreader."

("agrarteute" magazine - Set out the trays and earn money - 02/2019)

EasyCheck

Precise spreading made easy!



Digital, mobile test kit for the easy optimisation of the lateral distribution

Instead of testing trays, such as those found in the normal mobile test kit, the EasyCheck system consists of just 16 lightweight test mats made from rubber and the EasyCheck App for Smartphones. The test mats are positioned in pre-determined distances away from the tramline. Then the relevant tramline is spread and the mats with the fertiliser granules laying on them are photographed. The App now compares automatically how much fertiliser has been collected on each test mat and sets the results of the individual rows to an average. In cases where the spreading results are not the optimum, the App suggests readjustments for the setting of the relevant fertiliser spreader.



EasyCheck – Smartphone App for fertiliser spreaders

- 1 The new EasyCheck rubber mats from Amazone offer many advantages here. They are smaller and easier to handle.” (“agrarheute” magazine - Set out the trays and earn money - 02/2019)

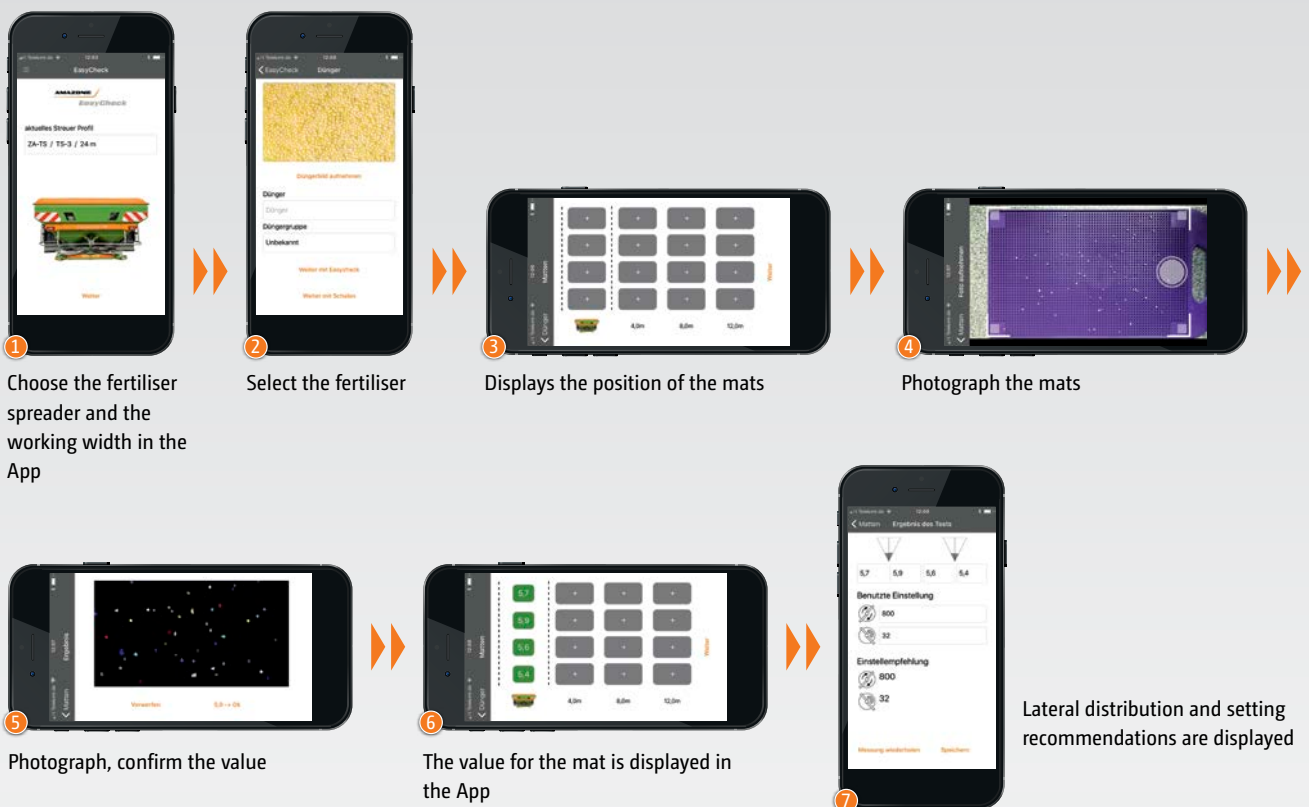

Technical data

ZG-TS trailed spreaders

Machine model	ZG-TS 7501 ProfisPro	ZG-TS 10001 ProfisPro
Working width (m)	15–54	
Hopper volume (l)	7,500	10,000
Permissible total weight (kg)	12,500	12,500
Max. payload (kg)	8,650	8,500
Filling height (m) + static tyre radius	1.71	1.98
Filling width (m)	4.09	
Filling depth (m)	1.94	
Total length (m)	7.33	
Total width (m), (depending on the tyres fitted)	2.48–2.90	
Total height (m), (depending on the tyres fitted)	2.68–3.03	2.95–3.30
Spreading disc drive options	Hydro drive with oil supply exclusively from the tractor oil requirement with steering axle max. 130 l/min oil requirement without steering axle max. 105 l/min Hybrid drive with combined oil supply oil requirement with steering axle max. 85 l/min oil requirement without steering axle max. 60 l/min	
Weighing system	ProfisPro / Frame integrated weighing system with 4 weigh cells	
Min. weight (kg) (without optional equipment)	3,850	4,000

Illustrations, content and technical data are not binding! Deviations of technical data are possible depending on the equipment. The illustrations may deviate from the requirements for local road traffic regulations.



ZG-B trailed spreaders

Machine model	ZG-B 5500	ZG-B 8200
Hopper volume (l)	5,500	8,200
Unladen weight (kg)	2,500 – 3,500	
Permissible total weight (kg)	8,000 – 10,000	8,000 – 12,000
Payload on public roads (kg)	5,900 – 7,700	5,800 – 9,800
Filling width (m)	3.45	
Total length (m)	6.70	
Total width (m), (depending on the tyres fitted)	2.26 – 2.75	
Total height (m), (depending on the tyres fitted)	2.26 – 3.10	

Illustrations, content and technical data are not binding! Deviations of technical data are possible depending on the equipment. The illustrations may deviate from the requirements for local road traffic regulations.





AMAZONE



AMAZONEN-WERKE H. Dreyer GmbH & Co. KG

P. O. Box 51 · D-49202 Hasbergen-Gaste/Germany

Phone: +49 (0)5405 501-0 · Fax: +49 (0)5405 501-193