



AMAZONE

ZA-TS



**AMAZONE spreaders
fulfil all European
environmental
standards**

ZA-TS mounted spreaders

The high output spreaders from AMAZONE



- ❗ “If everything is adjusted correctly one doesn’t need to worry about anything.”
(profi – Spreading systems in practice “hydraulic or mechanical” · 06/2017)

The ZA-TS mounted spreader is available in hopper capacities from 1,400 to 4,200 l and is equipped with the new TS spreading system. The TS spreading system enables working widths of up to 54 m with, simultaneously, excellent border spread patterns making the ISOBUS ZA-TS spreaders one of the absolutely top performing spreaders.

The reliable weighing system, the precise AutoTS and ClickTS border spreading systems, the innovative ArgusTwin and WindControl technologies and also the many other options make this fertiliser spreader a class apart.



ZA-TS

precise – quick - convenient

	Page
The advantages at a glance	4
Frame and hopper Extensions	6
Weighing frame Tilt sensor	8
Spreading disc drive Low level sensor FlowCheck	10
Soft Ballistic System pro	12
TS spreading system Agitator	14
Delivery and agitation Metering aperture setting motors	16
TS spreading discs Normal spreading	18
Border spreading systems Border spreading	20
AutoTS ClickTS	22
Border and bed spread deflectors Front-mounted spreading	24
HeadlandControl	26
ArgusTwin	28
WindControl	31
Equipment	32
ZA-TS model overview	34
ISOBUS	36
Spreader Application Center EasyCheck	46
Technical data	48

❗ “The application rate of the weigh cell spreader was always correct. We also liked the lateral and longitudinal distribution.”
(dlz agrar magazine – Long term test
ZA-TS “Wide throwing master“ · 01/2016)

❗ “Anyone who operates in sloping terrain or that has to struggle against heavily deviating fertiliser properties, or on very large working widths with poor throwing fertilisers, will be grateful for this new precision.”

(dlz agrar magazine – Long term test
ZA-TS 3200 Profis Hydro · 02/2017)

The ZA-TS mounted spreader

More precision. Maximum efficiency.

Up to **650 kg/min**



Working widths of up to

54 m



The advantages at a glance:

- ⊕ Precise spread patterns of up to 54 m working width with up to 128 part-width sections
- ⊕ Maximum work rates with outputs of 650 kg/min and operational speeds of up to 30 km/h
- ⊕ The deep-drawn base hopper without edges and corners ensures the lowest residues and easy cleaning
- ⊕ Precise monitoring and control of the application rate via the 200 Hz weighing technology and tilt sensor
- ⊕ Soft Ballistic System pro (SBS pro) for an especially gentle handling of fertilisers and less fertiliser damage
- ⊕ AutoTS and ClickTS, the disc-integrated border spreading system, electric or manual
- ⊕ Electrically-driven and fertiliser protecting agitation system with automatic shut-off
- ⊕ Automatic adjustment of the lateral distribution via ArgusTwin – possibly the most comfortable way of spreading fertiliser
- ⊕ Compact, tight-fitting and operator-friendly roll-over hopper cover or simple swivel hopper cover
- ⊕ FertiliserService, top-class quality, unique service with more than 25 years' experience

From **1,400** to **4,200 litres**

8 different hopper sizes

Up to **30 km/h**

operational speed



AMAZONE spreaders
fulfil all European
environmental
standards



MORE INFORMATION
www.amazone.net/za-ts

Frames and hoppers

Robustness is the key



ZA-TS 2000 Profis Tronic

Outstanding design: mounted spreader with 4500 kg payload.

The frames

- ✔ **Super frame:** 3,200 kg payload, Cat. II linkage dimensions and fixing pins.
- ✔ **Ultra frame:** 4,500 kg payload, Cat. III linkage dimensions and Cat. II/III fixing pins.

The benefits

- ✔ lightweight frame design with excellent rigidity
- ✔ optimised centre of gravity and yet plenty of space for hitching up
- ❗ “For Amazone, their payload of up to 4.5 t is the highest.”
(profi – PracticeTest “Four fertiliser spreaders in comparison” · 01/2016)

The deep-drawn hopper

The base hopper has a volume of 700 l. It is deep-pressed without corners, edges and weld seams ensuring the continuous and the even flow of the fertiliser. Also the cleaning of the spreader is made easy thanks to this design.

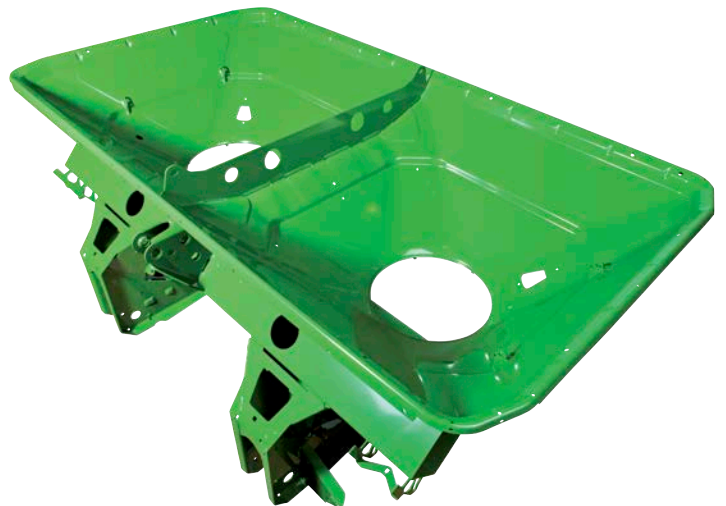

Benefits of the design

- ✔ No corners and edges
- ✔ Even and constant flow of the fertiliser
- ✔ Less danger of bridging
- ✔ Corrosion resistant
- ✔ Simple cleaning procedure

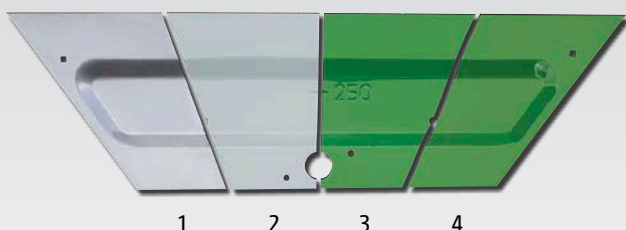

- ✔ High quality multi-layer paint finish
 - 1) sheet steel
 - 2) zinc phosphate (galvanising layer)
 - 3) KTL priming coat
 - 4) top coat

The extensions

In two widths and many sizes

The wide option
with a filling width of 2.71 m and
with twin folding ladders



L 2200 extension

The narrow option
with a filling width of 2.22 m



S 1400 extension S 1700 extension



L 2700 extension



S 2000 extension



L 3200 extension



S 2600 extension with single folding ladder



L 4200 extension

Additional hopper extensions

For a subsequent increase in hopper capacity for the ZA-TS, AMAZONE offers for both the S and L base machines a suitable bolt-on extension.

The volume of the extension is 600 l for S hoppers and 800 l for L hoppers.

- ✓ The direct filling from a tipping trailer or from big bags is no problem. Especially when using large loading shovels the wide L extension is of major benefit.

ZA-TS with L 800 hopper extension



Profis weighing technology –

Who weighs wins!



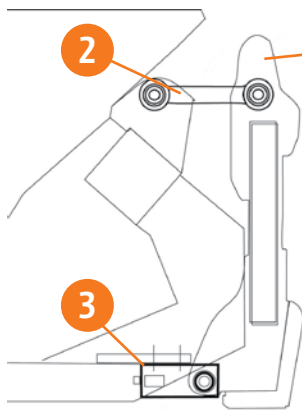

- ① weighing frame
- ② horizontally aligned tie rods
- ③ weigh cells



✔ Compact tractor mounting

No calibration: enter the spread rate and drive off! There is nothing simpler.

The weighing system provides controlled convenience and more safety enabling an on-line determination of the different spreading material properties with two 200 Hz weigh cells – with high measuring accuracy. It automatically compares the actually applied rate with the pre-determined rate. Deviations in the flow characteristics, for example when

spreading blended mineral fertilisers, are detected and the spreader is re-adjusted automatically via the electric metering shutter slides. In addition, for field-related nutrient application, for example, the applied rate is precisely documented. For a well-balanced nutrient supply, the application rate can be changed via the ISOBUS terminal at the touch of a button.

Tilt sensor for heavily undulating terrain

With the Profis, possible changes in the centre of gravity are taken into account during the measuring procedure whilst on the move via the tilt sensing technology: the two-dimensional tilt sensor which records the angle, both to the front and the

rear and to the left and right hand side, corrects the measuring inaccuracies which might arise when driving up and down hill or that might occur when driving on sloping ground.

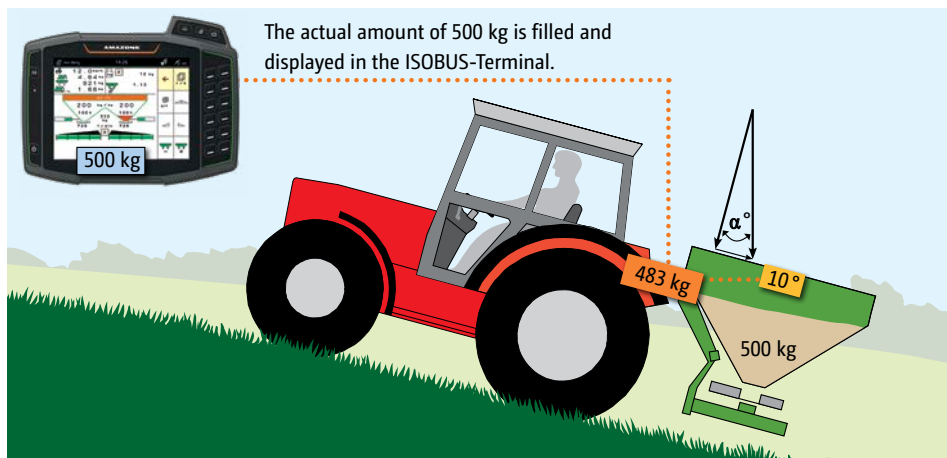

Example:

- The tilt sensor records the inclination of 10°
- The weigh cell on the ZA-TS Profis records 483 kg

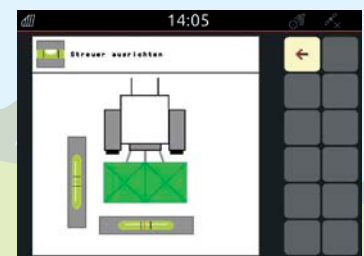

- ✔ For simplifying the mounting of the ZA-TS onto the tractor in the horizontal position, the angle of the ZA-TS Profis is comfortably displayed in the ISOBUS terminal.

The spreading disc drive

Mechanical or hydraulic, choose for yourself!

Tronic – mechanical spreading disc drive

With the Tronic version, the spreading discs are driven via the PTO shaft, with the spreader being protected from overload, as standard, via a PTO shaft with friction clutch. The input speed from the tractor PTO is transmitted via the central gearbox resulting in an increased spreading disc speed. This allows fertilisation at low engine revs across the maximum working width.

With the mechanically driven spreaders, either 8 or 16 part-width sections are switchable, depending on the operator terminal.

Hydro – hydraulic spreading disc drive

The Hydro version makes operation possible irrespective of the tractor's engine revs and with different spreading disc speeds. In this way, fuel is saved and a particularly comfortable and precise spreading is ensured. Also when border spreading, the spreader operates with different spreading disc speeds so that, both in the overlap range and also at the field's border, the best possible lateral distribution can be achieved.

With the hydraulically-driven spreaders, between 8 and 128 part-width sections are switchable, depending on the operator terminal.

✔ With a pressure filter as standard

❗ “The speed of the discs is always maintained and also, above all, in this way the possibility to set different spreading disc speeds is a poem. One really gets to know, and to evaluate, the benefits offered by the hydraulic system, after having used it”
(profi – “Spreading systems in practice “hydraulic or mechanical”. 06/2017)

✔ ZA-TS-Tronic –
mechanical spreading disc drive



Reliable in every detail



✔ Low level sensor for the ZA-TS

Low level sensor

When spreading on slopes or when border spreading it can happen that one hopper tip is emptied quicker than the other. In order to check each outlet apertures individually, AMAZONE therefore additionally offers low level hopper sensors. With a premature emptying of one side, the relevant hopper tip is indicated in red in the operator terminal so that the driver is warned early enough.

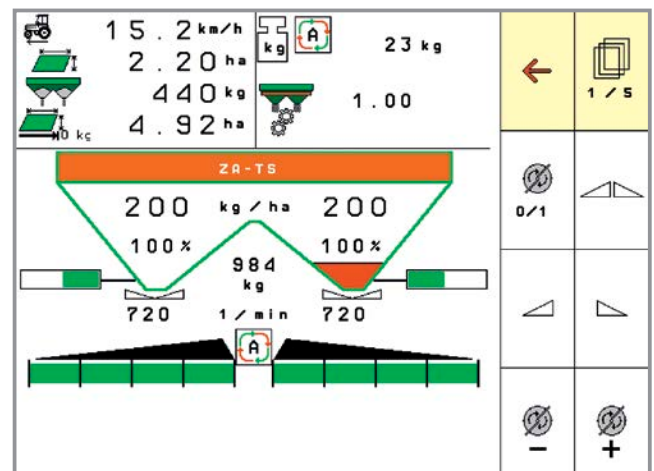

The driver receives an early warning, via the terminal, that one hopper tip is almost empty.

FlowCheck – for monitoring the spreader aperture

With FlowCheck, AMAZONE offers a system that continually monitors the shutter apertures against blockage or should they run empty. Whereas FlowCheck ensures that the application rate is the same on both sides or, in case of any deviation, informs the driver of a potential error.

The overall application rate is monitored and regulated via the weighing system. In addition, the driver is always informed via the weigh-cells of the actual fill level in the hopper.

✔ ZA-TS-Hydro – hydraulic spreading disc drive with the optional FlowCheck



✔ FlowCheck sensors in the hydraulic circuit

Soft Ballistic System pro

For an even gentler fertiliser treatment



4 decisive advantages with SBS pro

Mineral fertilisers require an especially gentle treatment to ensure a precise distribution and accurate transport to the crop. Fertiliser which has been already damaged in the spreader can no longer be reliably distributed.

As a safety feature, AMAZONE Soft Ballistic System pro is integrated as standard. This means that the agitator, metering components and spreading discs are all optimally matched thus protecting the fertiliser and ensuring better yields.

1. Gentle guidance

The electrically driven star agitators in the hopper bottoms ensure an even fertiliser delivery onto the spreading discs. The slowly rotating, star shaped segments of the agitator evenly deliver the fertiliser to the relevant outlet opening. When the delivery system is adjusted, the agitator star rotates as well so that it is always perfectly positioned above the aperture. The agitator switches off automatically when the shutter slide is closed.

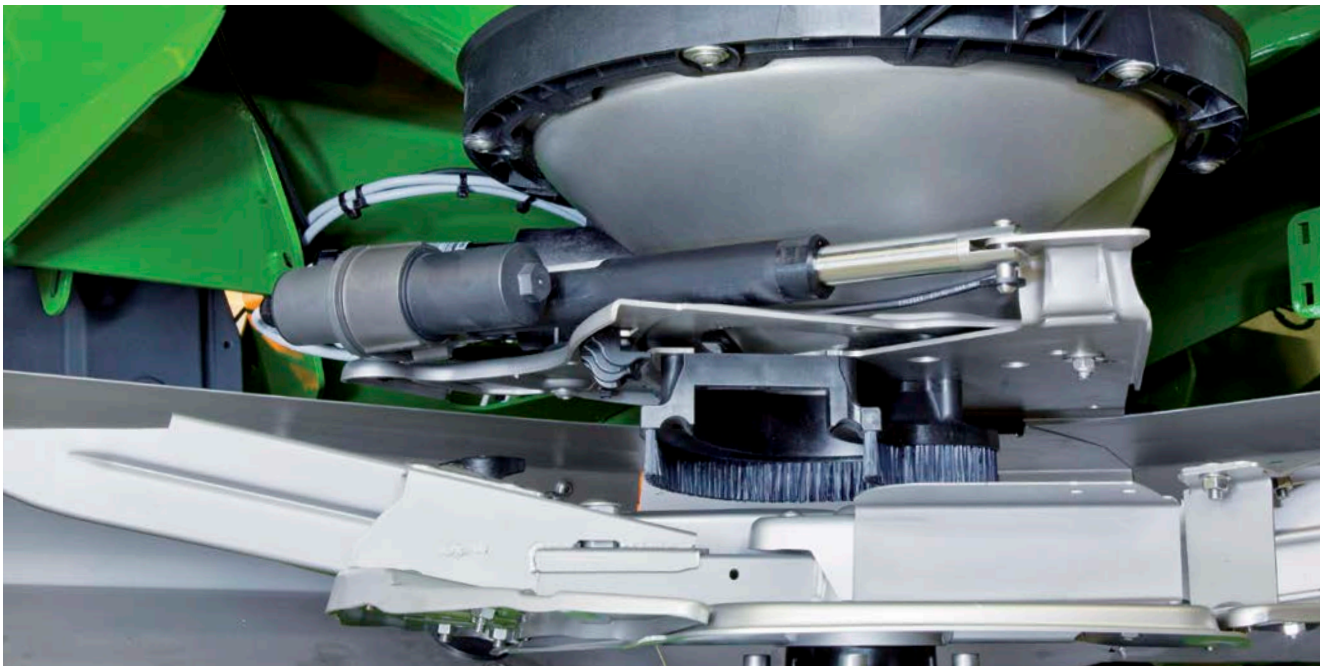

✔ Spreading system with delivery system, brush kit and spreading disc

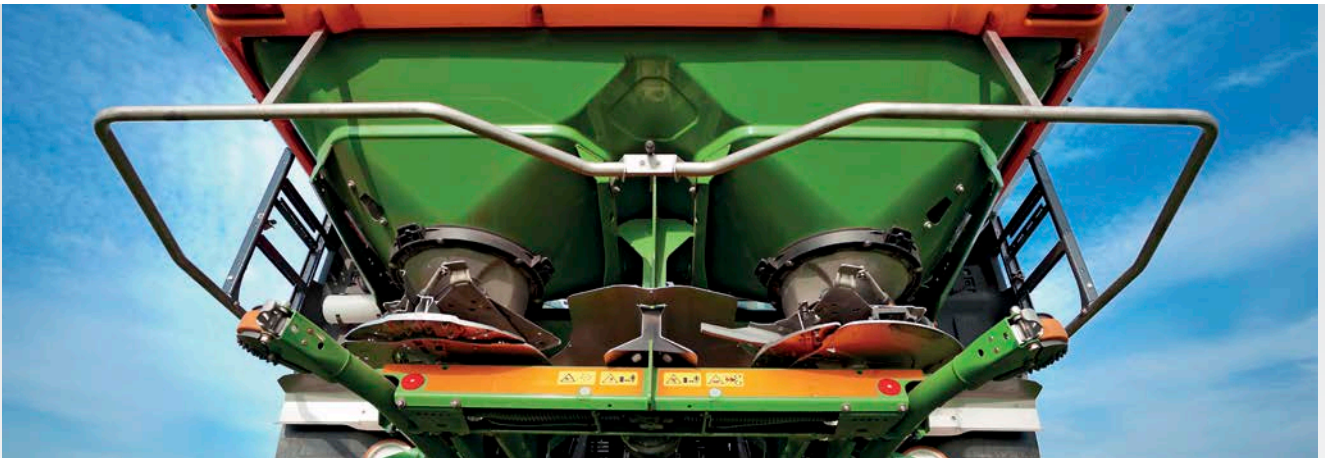

2. Gentle delivery

Due to the delivery system, adjustment to the throwing width and throwing direction can be regulated. In addition, the working width can be adjusted each side individually by changing the disc speed. The fertiliser is fed on centrally at a low peripheral speed resulting in little fertiliser damage. The concentric delivery system adjustment results always in a gentle treatment of the fertiliser.

3. Gentle acceleration

With a standard disc speed from 600 rpm up to 900 rpm, the AMAZONE's Soft Ballistic System pro gently accelerates the fertiliser. Even fertiliser types with minimal breaking strength maintain their spreading properties and provide a clean, even spread pattern.

4. Gentle ejection

With the AMAZONE Soft Ballistic System pro, as little energy as possible is given to the fertiliser for an optimum trajectory and a precise spread pattern. So, the spreading vanes are optimally adjusted to a laid-back position.



TS spreading system

Perfection in every component, like clockwork

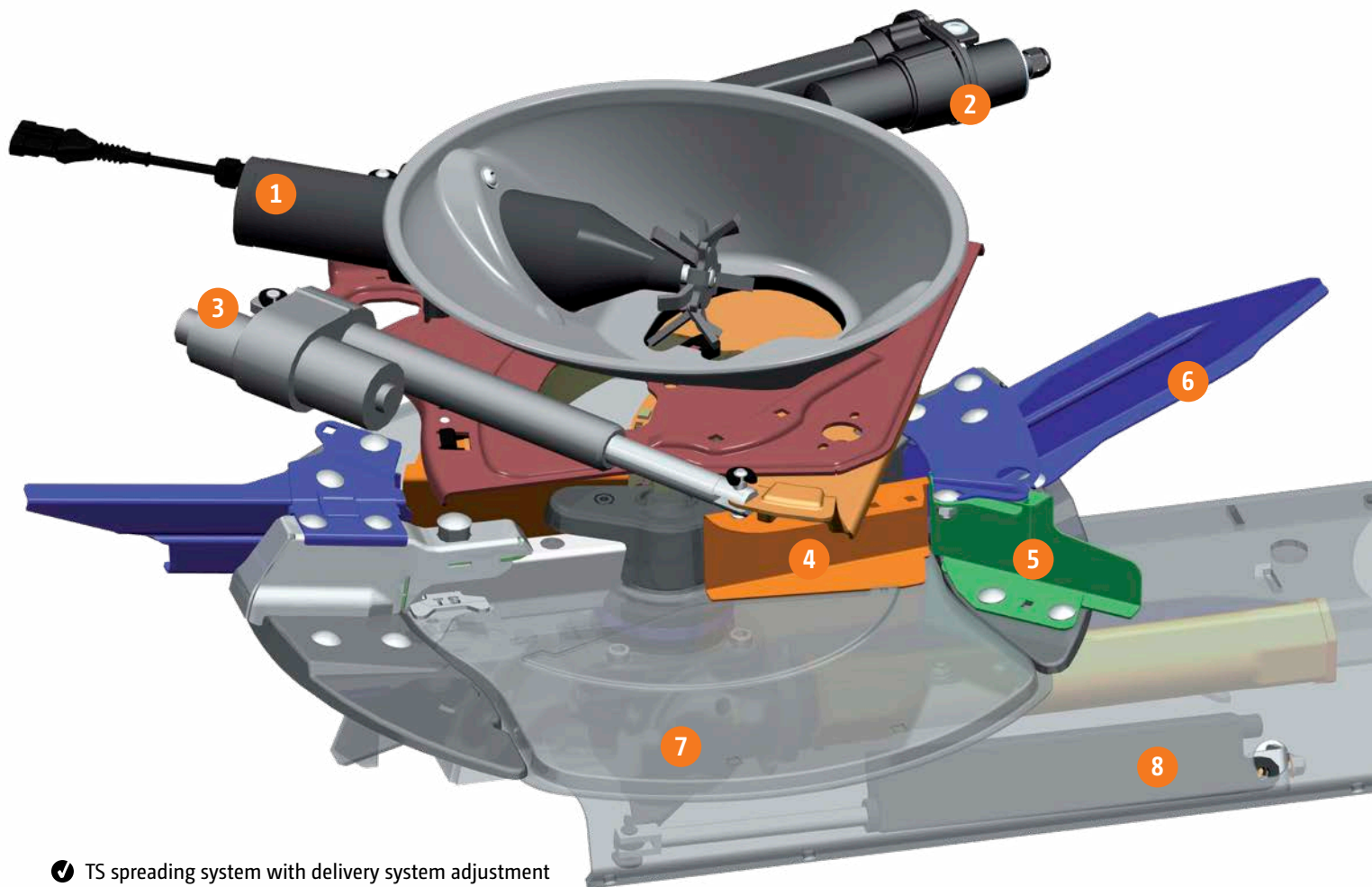

✔ TS spreading system with delivery system adjustment

Composition of the TS spreading system

- 1) electric agitator drive
- 2) electric setting motor for rotating the delivery systems
- 3) electric setting motor for the fertiliser metering
- 4) delivery vane
- 5) boundary spreading vane
- 6) normal spreading vane
- 7) AutoTS actuation
- 8) electric setting motor for AutoTS including function check

Characteristics of the TS spreading system

- ✔ High throwing width, still double-overlapping even at 36 m
- ✔ Integrated boundary spreading system
- ✔ High application rates (up to 10.8 kg/sec or 650 kg/min)

- ❗ “A 12V motor drives the agitator which rotates at 60 RPM. It switches off when the shutter is closed and it reverses as soon as a foreign object blocks the agitator.”

(dlz agrar magazine – Long term test ZA-TS 3200 Profis Hydro · 02/2017)



The agitator – soft-handling and gentle

The basic function of the agitator is to convey the fertiliser flow actively towards the outlet aperture so that a constant rate of fertiliser can be applied. Fertiliser lumps, which manage to pass the sieve, are, especially at low application rates, actively broken up via the star agitator which runs in the hopper bottom. If foreign objects reach the hopper tip and the agitator is subject to an overload, the relevant electric motor automatically reverses in combination with the relevant shutter slide and remedies the disturbance autonomously. The perfect teamwork of agitator and shutter slides becomes obvious on headlands or when spreading in wedges. As soon as one metering aperture is completely

closed, the agitator above stops automatically. In this way the valuable fertiliser is protected from being ground up.

The benefits of electric agitation

- ✔ two slow-running, fertiliser saving agitators; turning at just 60 rpm
- ✔ which switch off automatically as soon as the shutter slide is closed, also just to the one side and independently of each other
- ✔ that reverse automatically when blocked by a foreign object
- ✔ active delivery of the fertiliser flow to the outlet aperture

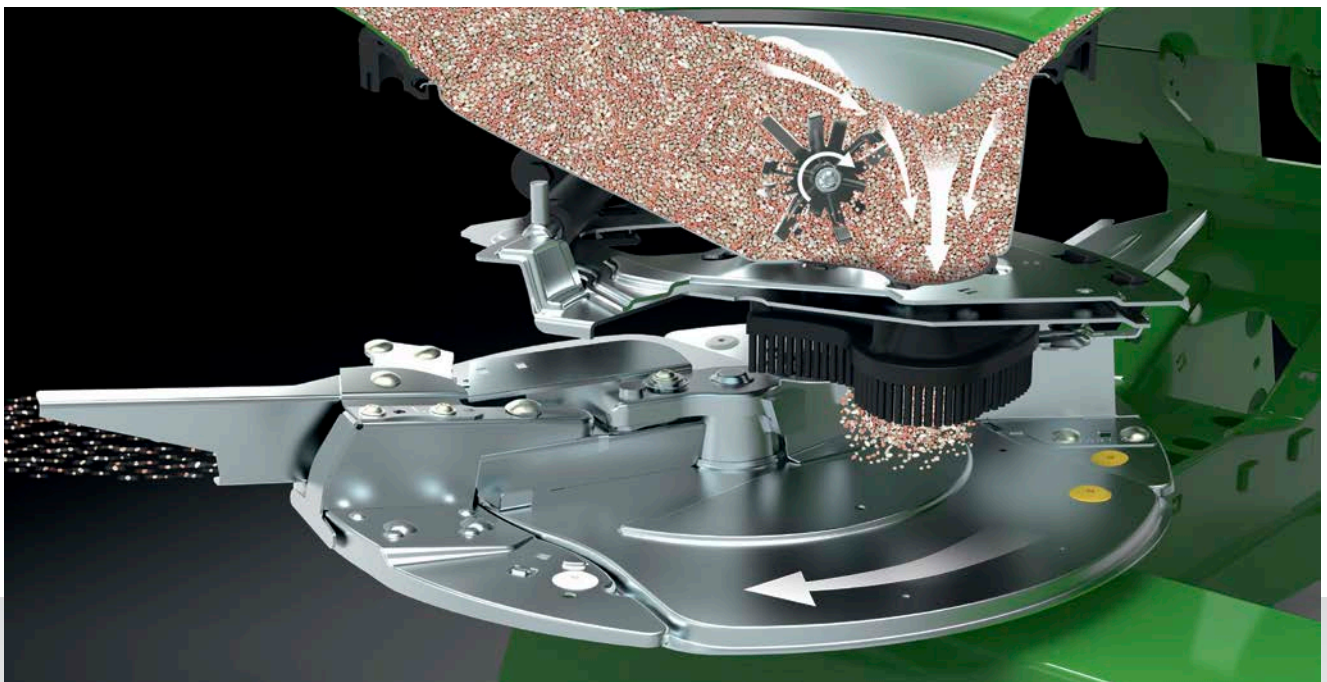

- ❗ “The electric agitators operate independently left or right and only when that shutter is opened”

(profi – Practice Test “Four fertiliser spreaders in comparison” · 01/2016)

The AMAZONE delivery system

For first-class spreading results

Concentric delivery system adjustment

Via the delivery system, the fertiliser is gently fed-on extremely close to the centre of the spreading disc. At this point, close to the centre of the disc; the peripheral speed is low resulting in a particularly gentle treatment of the fertiliser. For setting the spreading unit to different working widths and types of fertiliser, the delivery system is swivelled (concentrically) around the centre of the discs. The distance between the feed-on point of the fertiliser and the centre of the disc always remains the same.

The swivelling of the delivery system provides you with a wide range of possible working widths; just three sets of spreading vanes cover working widths from 15 m to 54 m.

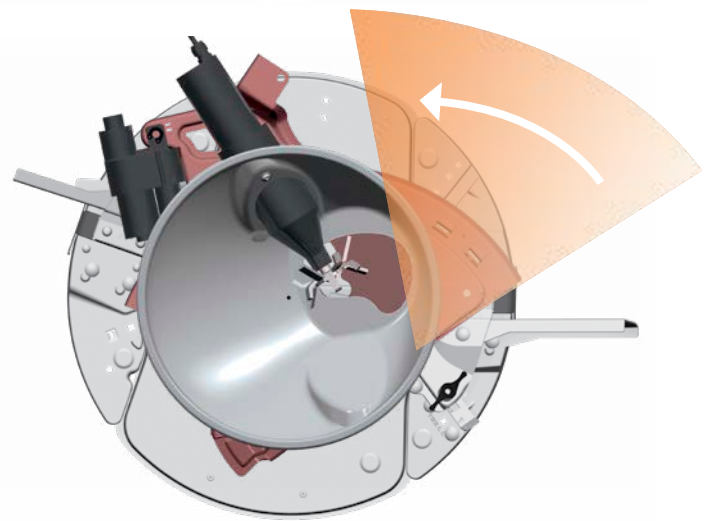
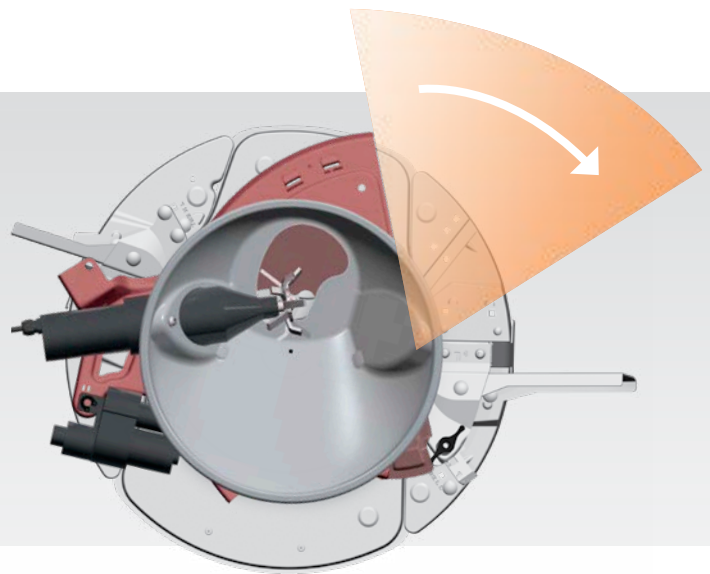

- ✔ The delivery system swivels around the centre of the disc



- ✔ Every TS spreading unit with electric delivery system adjustment is Argus ready



- ✔ Mechanical delivery system adjustment

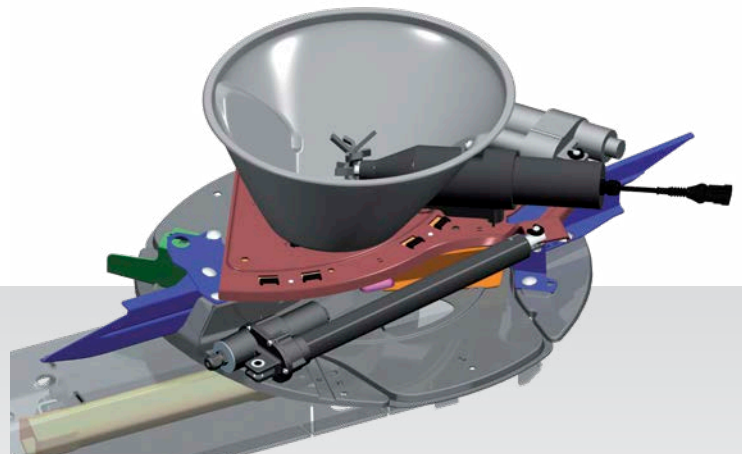

- ✔ Electrical delivery system adjustment

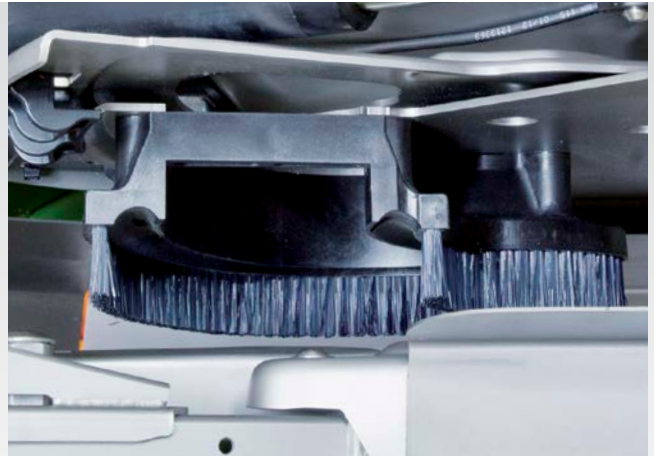

✔ Brush unit for a clean delivery onto the spreading discs

Ultra quick and precise! Electric setting motors

A spreader which, due to the high application rates and operational speeds possible, explores new dimensions in terms of work rates and which, of course, needs to perform extremely precisely at the same time, requires setting motors that function extremely quickly and exactly. Especially in applications, such as the automatic on/off switching at the headland or in wedges, spreading using application maps or with the continuous on-board monitoring (ArgusTwin and WindControl), the setting motors ensure the highest level demands are met.

Clean transfer – The brush unit

The bristles of the brushes which are fitted directly to the outlet apertures reach to the upper edge of the spreading vanes so that the fertiliser is safely delivered onto the disc.

Quantity effect-free metering aperture

If it is intended to spread a constant application rate it is necessary to match the size of the metering aperture to the prevailing operational speed. Thanks to the shutter slide, this task is fulfilled very quickly and sensitively. Due to the

kidney-shaped design of the metering aperture, the spread pattern remains unchanged and precise, even at varying operational speeds so that the position of the delivery system does not require any adjustment.



Stage 1: Hopper aperture slightly open



Stage 2: Hopper aperture half open



Stage 3: Hopper aperture wide open

TS spreading discs

For the utmost precision at all spreading widths up to 54 m

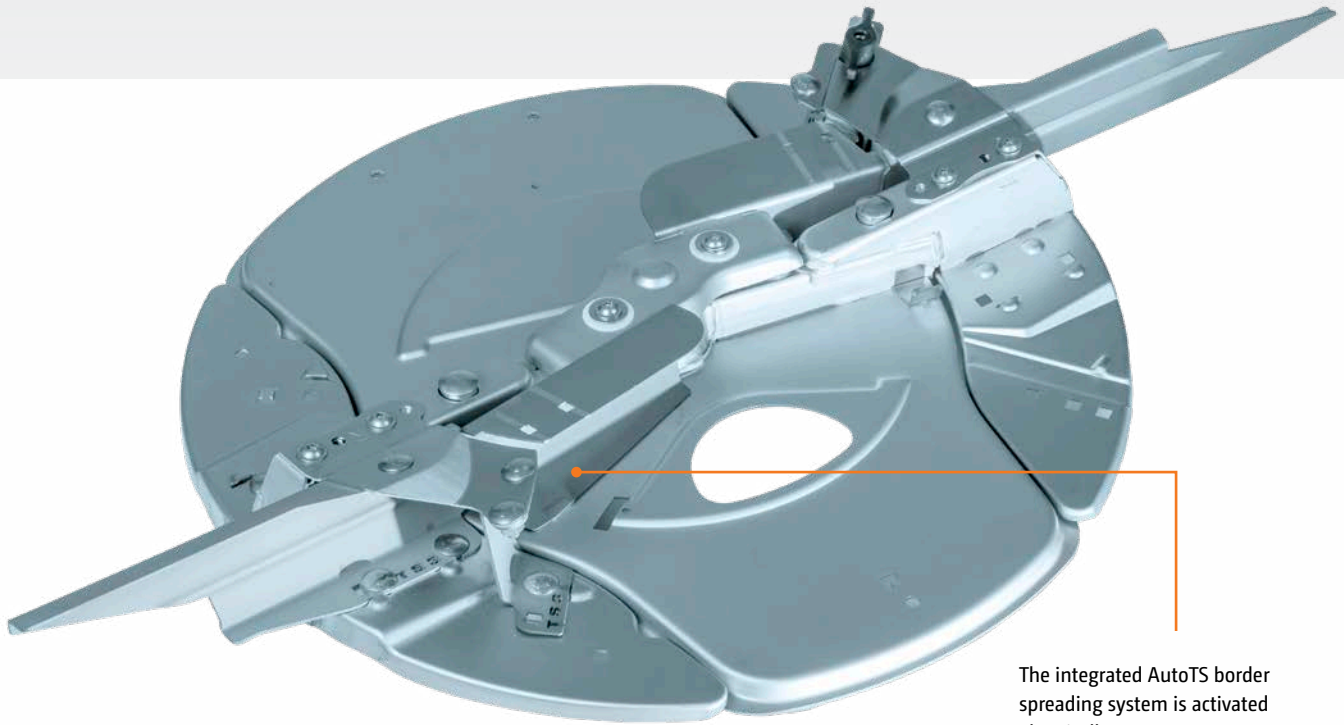

The integrated AutoTS border spreading system is activated electrically.

Spreading system made from stainless steel – for a long service life

On the TS spreaders the entire spreading system is made from stainless steel providing a long service life.

The vane change system enables the quick and easy change of just the spreading vane tips. The ideal solution, for example, for agricultural contractors.

Between normal spreading and border spreading, different spreading vanes are activated via the so-called AutoTS system without the necessity to change spreading disc settings.

Hard-coated spreading vane

The spreading vanes are coated with a special long-lasting anti-wear protection. This is made possible by an especially hard structure to the metal. This finish is produced through a high-speed flame heating process that develops an ultra-hard coating to protect the spreading vanes against abrasive wear. Consequently, the result is a three-fold increase in lifespan.

Spreading vane sets

- ✔ TS 1 = 15 m – max. 24 m
- ✔ TS 2 = 21 m – max. 36 m
- ✔ TS 3 = 24 m – max. 54 m

❗ "For different working widths it is then just a case of interchanging the spreading vane set – a very comfortable solution."

(profi – Driving impression ZA-TS 4200 Profis Hydro fertiliser spreader– 06/2013)

Optimised spread pattern



Normal spreading

Via the adjustment of the delivery system, the feed-on point of the spreading material on to the spreading disc is changed and thus the spreading width and the lateral distribution are controlled. In addition, the working width can be set even more individually by changing the disc speed.

Non-sensitive spread pattern via the multi-sectional spread fan

The specific shape and angling of the spreading vanes result in a multi-spread fan from the TS spreader unit. This means that the long and short spreading vanes do not influence the spread pattern to either side and an optimum trajectory is maintained.

Three-dimensional spread pattern

The spreading unit has been developed using three-dimensional spread patterns so that a perfect lateral distribution of up to 54 m working widths is achieved. The large overlap zones ensure a perfect spread pattern and are significantly more consistent with regard to any the external influences such as a side wind, change in topography, humidity and changing fertiliser qualities.

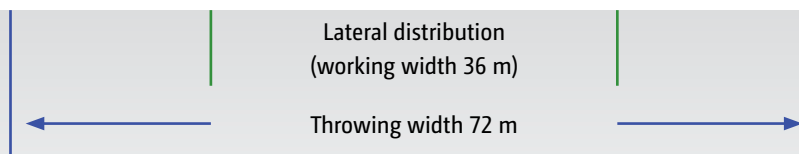
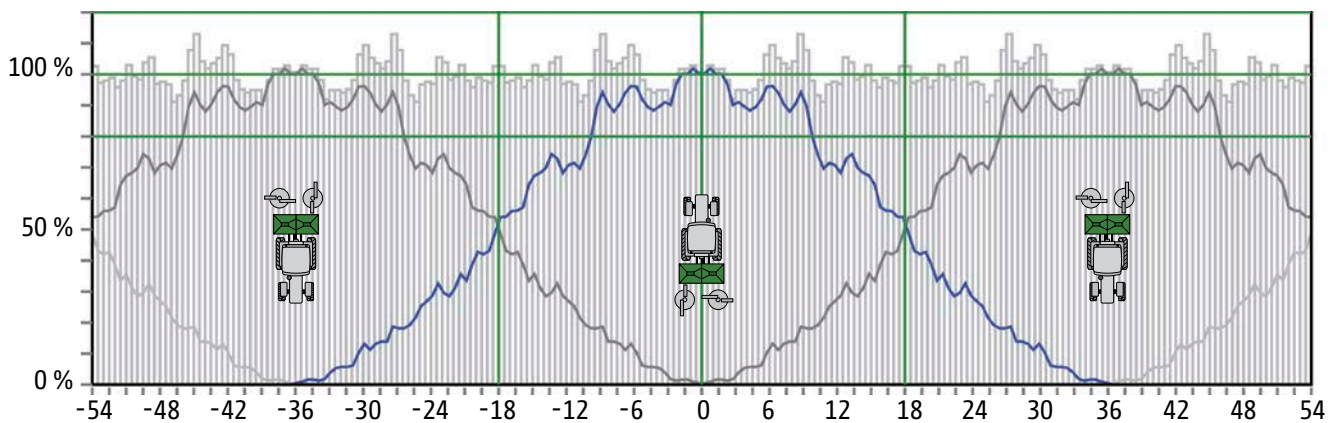
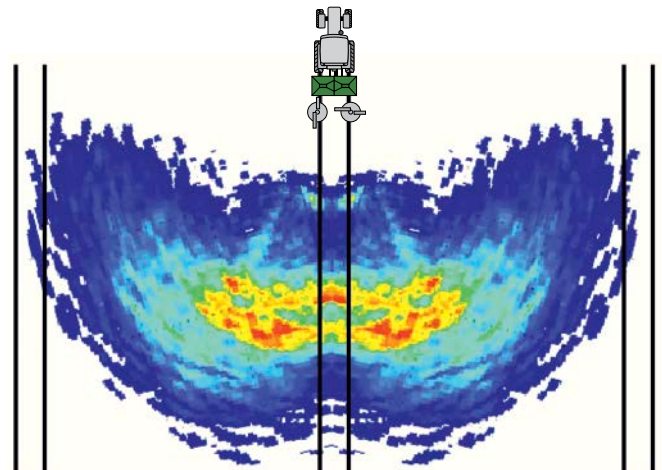

Border spreading systems from AMAZONE

Complete control. At any time!



- ✔ Watercourse spreading: highest distribution accuracy up to 1 m towards the field's border

Effective and precise – spreading only where the fertiliser is of benefit to your plants

Side spreading (yield oriented setting)

The neighbouring field is an area that is used agriculturally. In this case it is tolerable for a small quantity of fertiliser to be thrown over the border of the field. The fertiliser distribution inside the field boundary is still 80% of the desired application rate at the edge of the field.

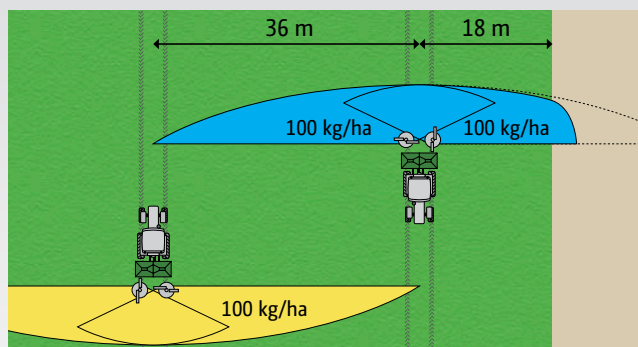

Boundary spreading (environmentally oriented setting)

If the field is adjacent to a road or cycle path, no fertiliser must be thrown beyond the border of the field. The spread rate must be reduced on the border side so that no over-fertilisation occurs within the boundary of the field. A small amount of under-fertilisation occurs up to the edge of the field. The border spreading procedure complies with fertiliser application legislation requirements.

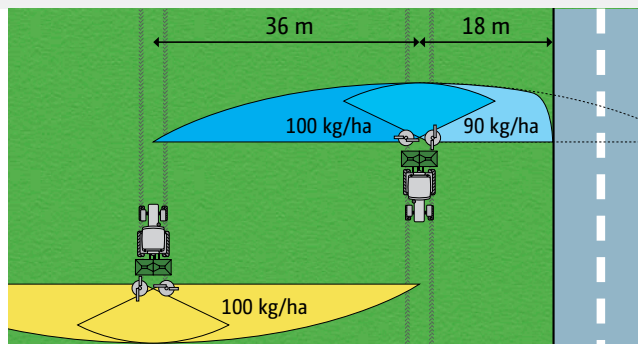

Water course spreading (environmentally oriented setting)

In case of a water course right against the side of the field, the fertiliser decree requires, with a boundary spreading system, a distance of one metre left fertiliser-free around the border and, without a boundary spreading system, as much as three metres. In order to avoid the over-fertilisation inside the field, the spread rate has to be reduced on the field's border.

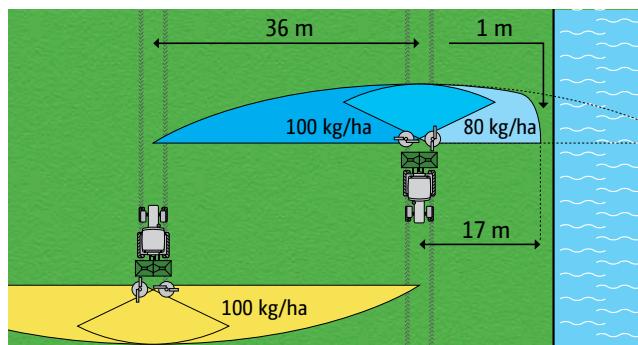

Border spreading with the border spread deflector

If the first tramline is situated at the field's edge, border spreading (environmentally-orientated adjustment) is then achieved by the half-side shut-off of the spread fan. No fertiliser is thrown beyond the field's border and, inside the field, optimum fertilisation is maintained.

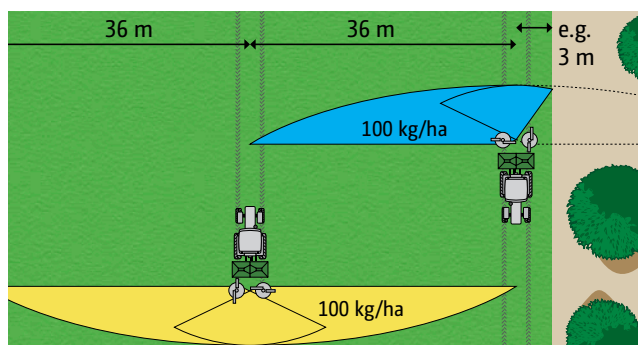

Bed spreading with bed spreading deflector to both sides

For spreading specialist crops in beds to either side of the tractor AMAZONE offers the bed spreading deflector. It keeps the track virtually free from fertiliser.

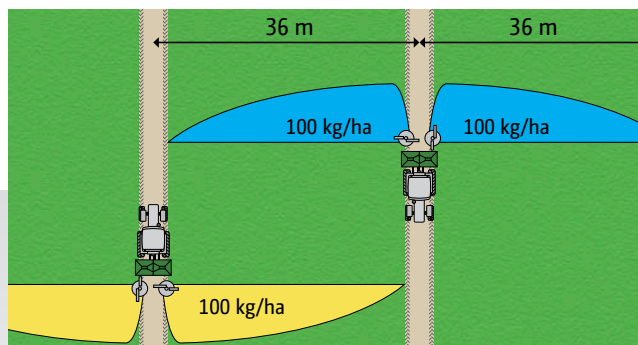

AutoTS + ClickTS

The disc integrated boundary spreading systems

AutoTS – comfortable and precise Lateral distribution right up to the field’s border

The disc-integrated AutoTS border spreading system enables the activation of the different border spreading procedures – side, border or watercourse spreading – comfortably via the Terminal in the tractor cab, irrespective of which side.

AutoTS – the ingenious principle

A setting motor twists the delivery vane forwards by approximately 10 ° so that, when border or watercourse spreading, the fertiliser is delivered via the shorter border spreading vanes. Due to the combination of disc speed and shorter vane, the fertiliser is thrown over a significant shorter distance without affecting it mechanically.

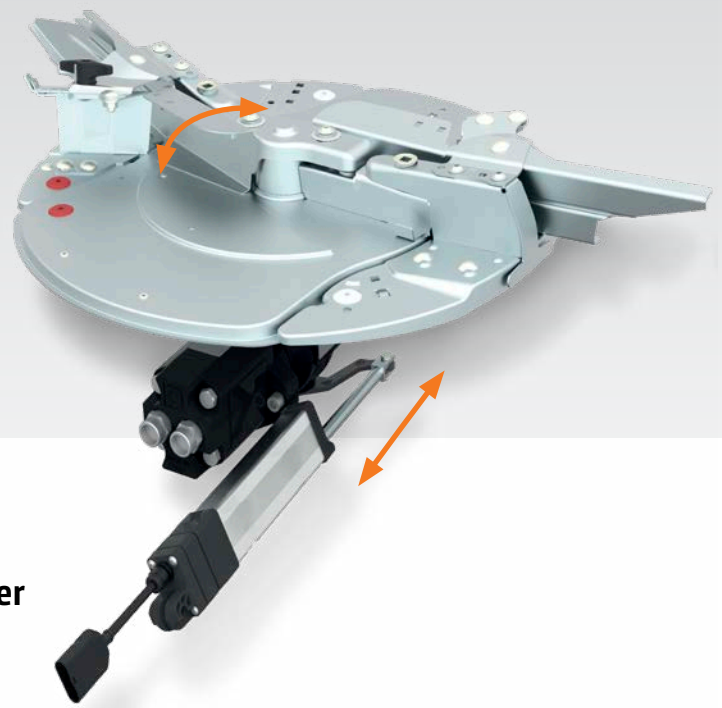

AutoTS – adjustment of the delivery vane for boundary spreading

❶ “The design specification for the development of the Amazone ZA-TS was clear: No longer should there be any compromise between normal spreading and side, border and watercourse spreading around the field border.”

(profi – Spreading devices in practice “hydraulic or mechanical” · 06/2017)



AutoTS – adjustment for normal spreading



AutoTS – adjustment of the delivery vane for boundary spreading

✓ Border spreading with ClickTS
 As an alternative to having the AutoTS system on both sides that can be controlled remotely from the tractor cab, there is now the option of AutoTS just on the one-side alongside the manually-adjusted ClickTS on the other. ClickTS is possible on both sides as well.



Increased yield on the border thanks to AutoTS and ClickTS

The AutoTS and ClickTS border spreading systems generate a steep border spread pattern and thus the ability to provide the optimum growth conditions close to the field's border. Compared to other border spreading systems, a significant increase in yield is possible.

The AutoTS spreading system makes use of an automated rate reduction when boundary spreading with the spread rate setting in freely-selectable percentage steps. As the two spreading discs can be operated independently from one another, the change to one or both sides can be adjusted.

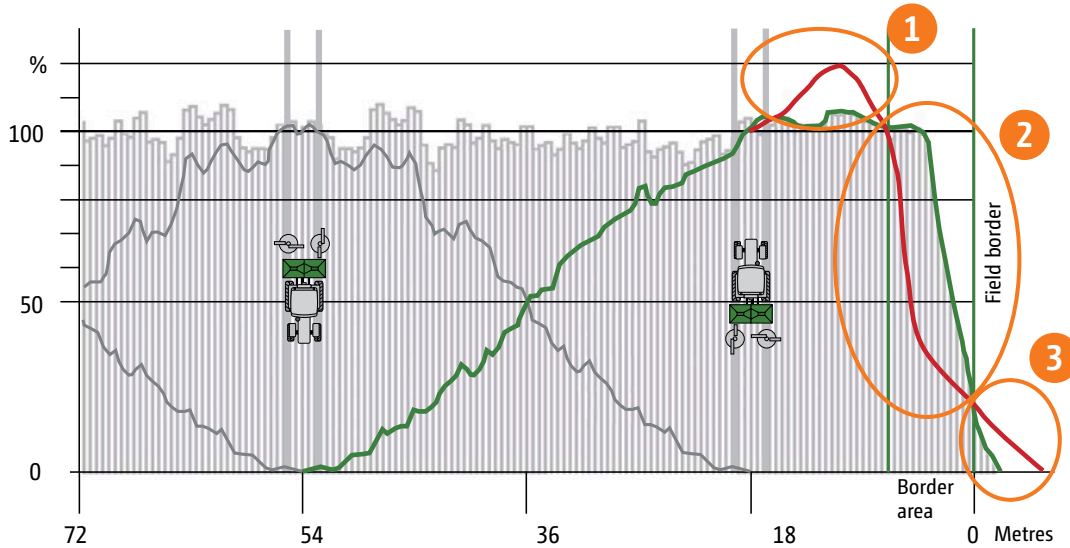

	AutoTS border spreading system	Conventional border spreading systems
1	Due to the shorter spreading vane, the fertiliser is limited in its spreading width.	The mechanical deflection of the fertiliser causes damage to the granules which then drop next to the tramline.
2	The fertiliser is undamaged and optimally distributed right up to the field border.	This amount of damaged fertiliser is then missing from the border area resulting in under-fertilisation.
3	Due to the reduced throwing speed of the fertiliser, only a few granules fall beyond the field edge.	Not all the fertiliser granules are mechanically deflected so that some are clearly spread beyond the field's border.

Border and bed spread deflectors

Border spread deflector

In the case of operation to spread directly from the field side into the inner field, the border spread deflector is available. When the border spread deflector is swivelled into work then spreading is carried out only with the field side spreading disc so that any fertiliser is deflected in such a way that it is thrown into the field and only behind the tractor, however, and not beyond the border. The border spread deflector can be utilised on both the left and right hand side. The actuation of the border spread deflector is carried out manually or, as option, hydraulically from the tractor seat. When swivelled out of work, the border spread deflector has no influence to the normal spreading.



Border spread deflector swivelled upwards

Bed spreading deflector

For spreading beds to either side of the tractor, the bed spreading deflector provides the optimum fertiliser distribution without spreading any material behind the tractor. For optimising the fertiliser distribution, the telescopic end pieces on the bed spreading deflector can be adjusted to suit, depending on working width and fertiliser type. The bed spreading deflector can be utilised to either one, or both sides and actuation of the bed spreading deflector is carried out, similar to when border spreading, either manually or, as an option, hydraulically from the tractor seat. If the bed spreading deflector is swivelled upwards then again the spreader can be utilised as usual for arable farming.

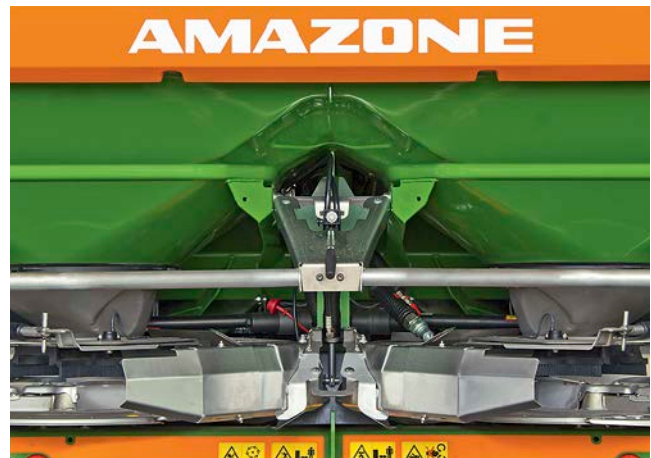

Bed spreading deflector swivelled downwards on both sides with telescopic end pieces.

Front-Rear duo

A new level of precision



Front spreader with suitable lighting system for travel on public roads

Two in one go

For customers who intend to accurately spread two different mineral fertilisers in just one pass, AMAZONE offers the unique possibility of a front-mounted spreader. Other than when utilising blended fertilisers in one fertiliser spreader, this option allows the optimal setting of each spreader according to the properties of the relevant fertiliser. In this way, the perfect lateral distribution for both fertilisers is achieved. Also spreading with two different application maps is possible.

Comfortable and reliable

To enable operation of a “reversed” fertiliser spreader on the front of the tractor, an intelligent software package is utilised which reliably mirrors the spreading function and required working without any rethinking. In this way,

Benefits of front-mounting

- ✔ Possibility to accurately spread two different types of fertiliser in just one pass
- ✔ More capacity from the additional hopper capacity yet with the benefits of a mounted machine – manoeuvrable and speedy
- ❗ “The spreader duo shows its strengths in its precision.”
- ❗ “The combination is manoeuvrable, efficient and improves the weight distribution on the front and rear axle.”
(*agrarheute* magazine– test report with the front mounted spreader · 09/2018)

even normal, side, border and watercourse spreading can be actuated on the correct side without any problems. Even the optimum switching points for the automatic on/off switching on the headland is matched.



Precise spreading of two different fertiliser types

HeadlandControl

Optimum lateral distribution on the headland

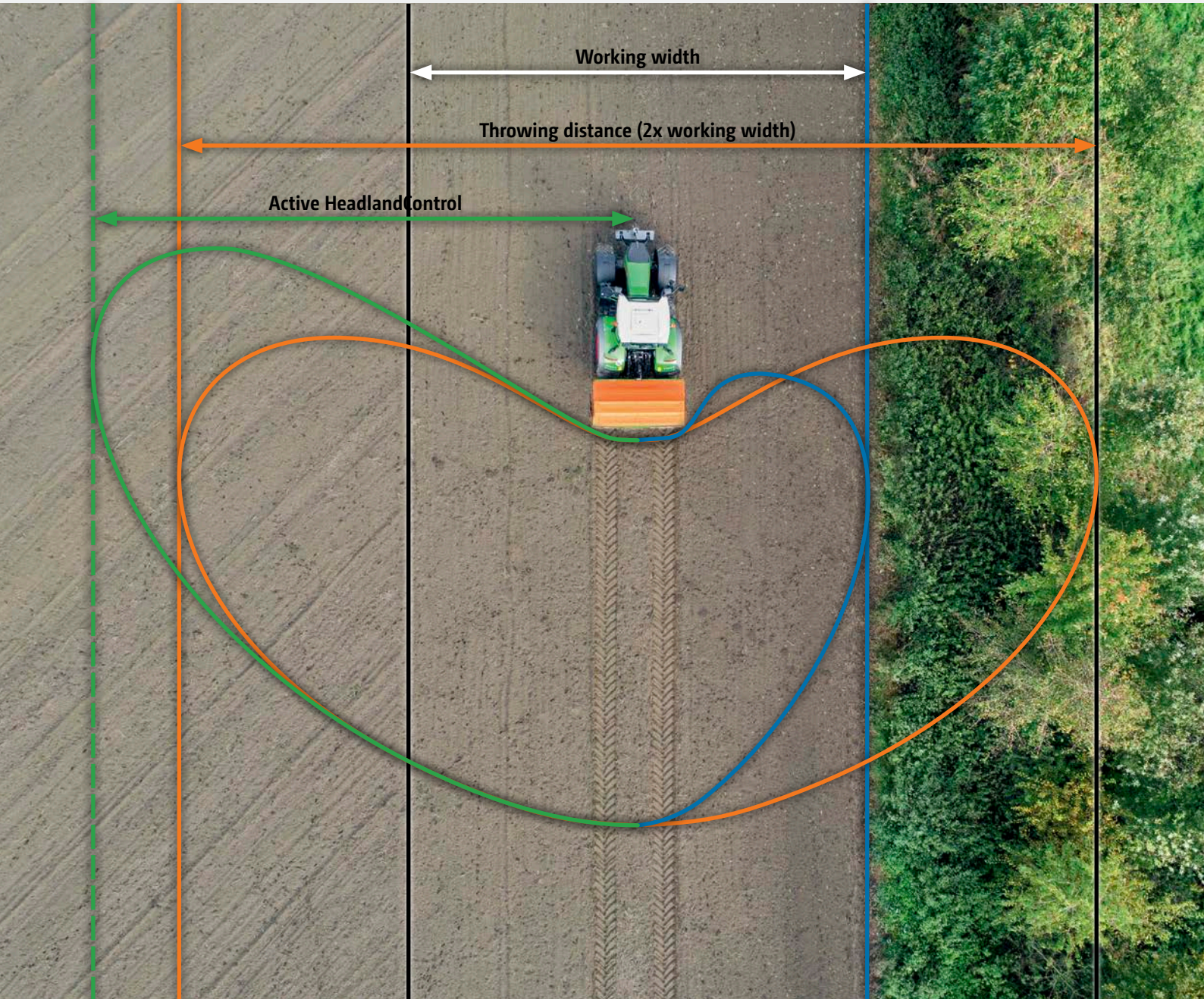

— HeadlandControl — Normal spreading — Border spreading

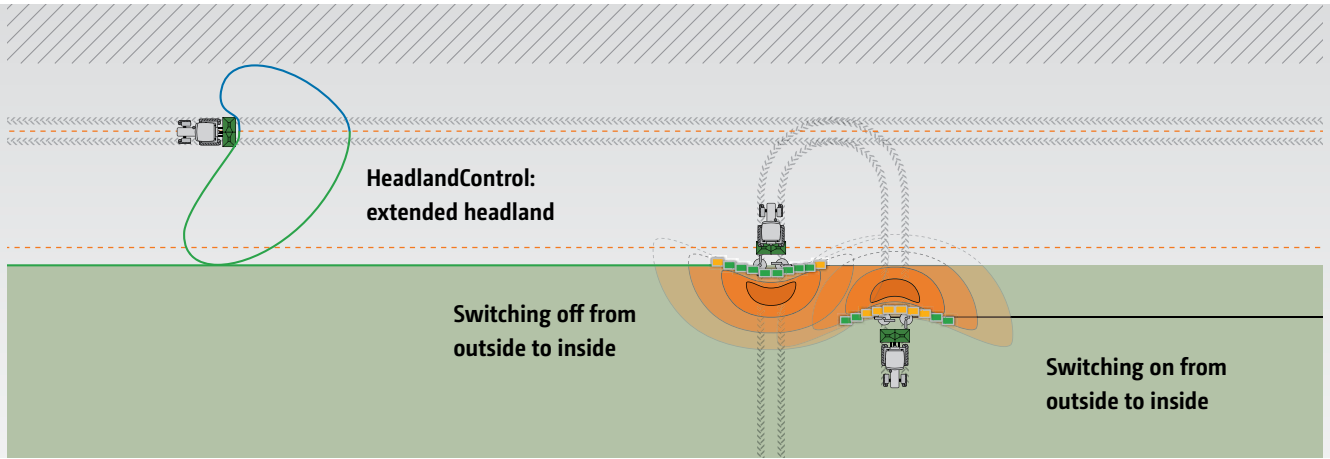

Perfected headland coverage thanks to HeadlandControl and the new part-width section control

The problem: Over- and under-fertilisation on the headland

Different fertilisers have different switch-on and switch-off points. In practice, the switch-off points are usually only achieved when the tractor is turning on the headland. The arc of spread behind the tractor swings round to the side creating areas that are either over- or under-fertilised.

The solution: HeadlandControl

When HeadlandControl is activated, the throwing width and spread rate are increased on the inner field side, so that the switch-off point is moved towards the inside of the field. Furthermore, the new part-width section control, which is now adapted to the shape of the spread fan, causes the part-width sections to be switched off from the outside to the inside when entering the headland. Over- and under-fertilised zones on the headland are subsequently avoided.

Switch-off time on the headland: Without HeadlandControl

1. Spreader switches off too late and is already turning
2. Tractor would have to drive beyond the headland tramline

Result: Over- and under-fertilised zones are created

With HeadlandControl

1. HeadlandControl means that the spreader continues to apply fertiliser to the crop when it is on the headland
2. The tractor can follow the wheel tracks of the sprayer

Result: Uniform crops across the headland

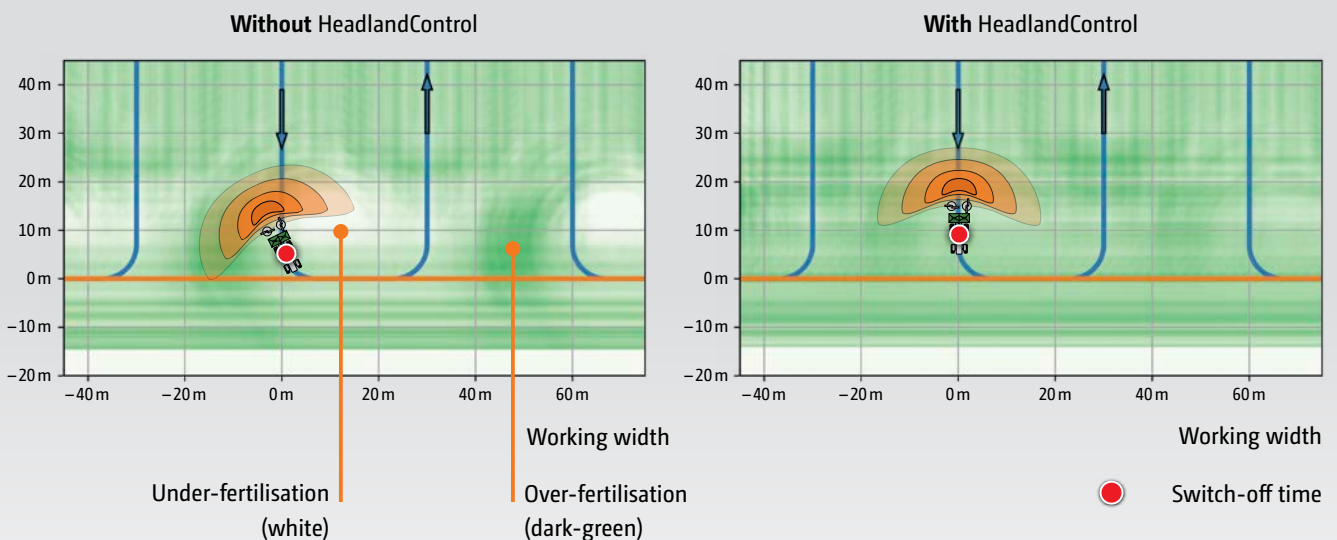

ArgusTwin

The spreader's eyes – it sees what you don't see!



Argus

❗ “ArgusTwin optimised the lateral distribution within seconds.”
(profi – Test report Amazone ArgusTwin · 01/2016)



ArgusTwin is completely integrated into the overall dimensions of the ZA-TS

Automatic adjustment to the optimum lateral distribution

Via the constantly working on-line monitoring and readjustment of the delivery system, the ArgusTwin system ensures an optimum lateral distribution of the fertiliser. This leads to a more effective fertiliser use and forms the basis for optimum crop management.

The Argus system, which checks the spread fan and automatically regulates the lateral distribution, is based on radar technology that is independent of dust and pollution and thus provides reliable results in practice. ArgusTwin constantly monitors, via radar sensors mounted on both the sides of the spreader, the left and right hand spread fans simultaneously and re-adjusts the electric delivery system independently of each other if necessary.

Automatic delivery system adjustment

Via the ISOBUS terminal, the application rate and any further relevant data for the fertiliser to be spread are entered from the setting chart. For the Argus system, the spreading chart has been updated to include the throwing angle that gives the optimum lateral distribution. Utilising this value, ArgusTwin constantly checks whether the predetermined direction of throw for that fertiliser is in fact being maintained by the spreading discs. When the actual throwing width deviates from the “desired” throwing width due to inconsistencies within the fertiliser, worn spreading vanes, working across slopes or during starting and stopping proce-

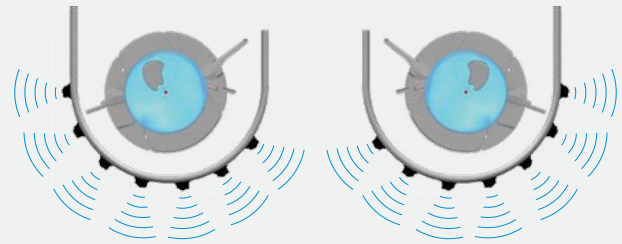

Independent monitoring of both sides of the spread fan via 14 radar sensors

dures, the spreader readjusts, on its own, the setting for the delivery system – and that of each side individually. The only pre-condition for its use is the electric delivery system adjustment.

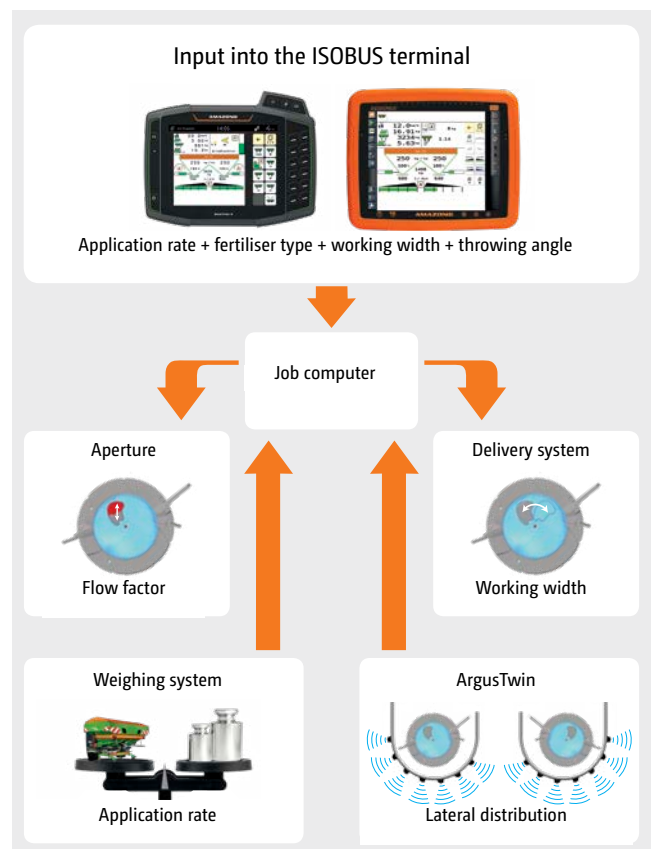

The concept of the fertiliser spreader with ArgusTwin and weighing system

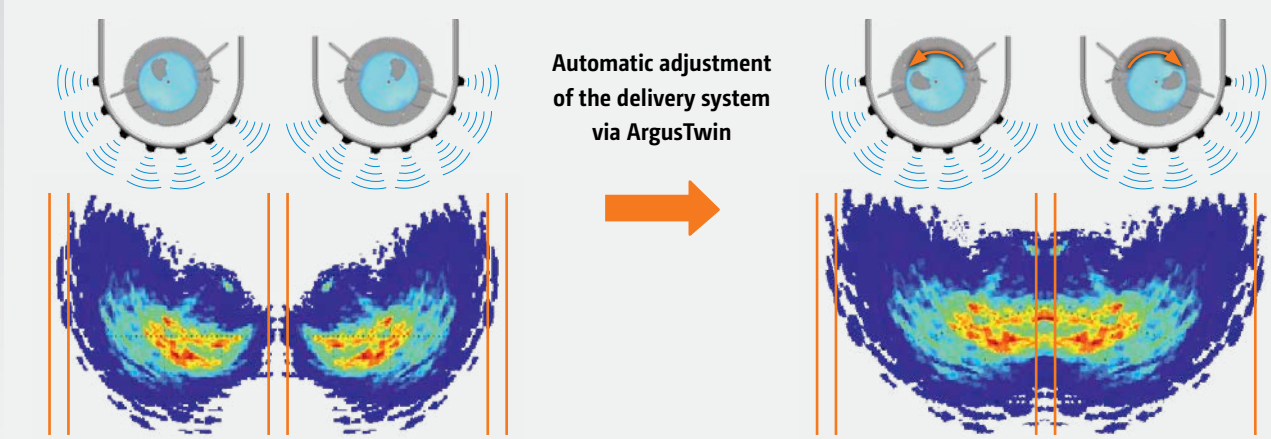

The problem in practice – poor lateral distribution, for instance, due to a change in fertiliser properties

The perfect lateral distribution gives evenly established crops even with changing fertiliser qualities and properties

The system is immediately live and operates even when border spreading and if part-width sections are switched off and on. In hilly terrain, Argus even provides slope compensation of the spread pattern via the automatic readjustment of the delivery position of the fertiliser.

While Argus optimises the lateral distribution, the optional weighing system ensures the maintenance of the application rate.

Top features of ArgusTwin:

- ✔ The system is ready for operation immediately
- ✔ Positioned directly above the spreading discs
 - the system is located safely between the outer guard tube and the base hopper
 - therefore no areas where moisture, dirt or fertiliser may deposit
- ✔ Constant on-line monitoring of both spread fans
- ✔ Maintains an optimum lateral distribution of the fertiliser even with changeable fertiliser quality
 - Basis for optimum crop management
 - More effective use of the fertiliser
- ✔ The system is also active when border spreading or if a part-width section is switched on or off
- ✔ Automatic slope compensation of the spread pattern by readjustment of the delivery system position
- ✔ Rigidly attached to the spreader: no moving parts – completely maintenance-friendly and free of wear



WindControl

for areas where wind is always a problem



- Both the wind speed and wind direction are displayed in the terminal

Optimal distribution

In areas that are particularly windy, AMAZONE now offers WindControl (in accordance with Prof. Dr. Karl Wild, HTW Dresden) as a supplement to the ArgusTwin system. Via WindControl, the influence of wind on the spread pattern can also be constantly monitored and automatically compensated for.

Mounted on the machine, a high frequency measuring wind sensor, registers both the wind speed and also the direction of wind. According to this data, the job computer then calculates, in conjunction with the information from ArgusTwin, any new settings for the delivery system and the spreading disc speed which are then automatically

acted upon. For side winds, the disc speed to the windward side is increased and the delivery system advanced whereas, at the same time, the disc speed on the leeward side is reduced and the delivery system retarded.

With the aid of WindControl, larger time windows are created for spreading under the influence of wind. Apart from all the important fertiliser spreader parameters, the user additionally always has, in view, the real-time direction of the wind, the force of wind and if the wind is gusting. In addition, in heavy winds, when the system is no longer able to compensate for, or when the wind gusts are too frequent, WindControl sends an automatic alarm to the driver.



Wind sensor

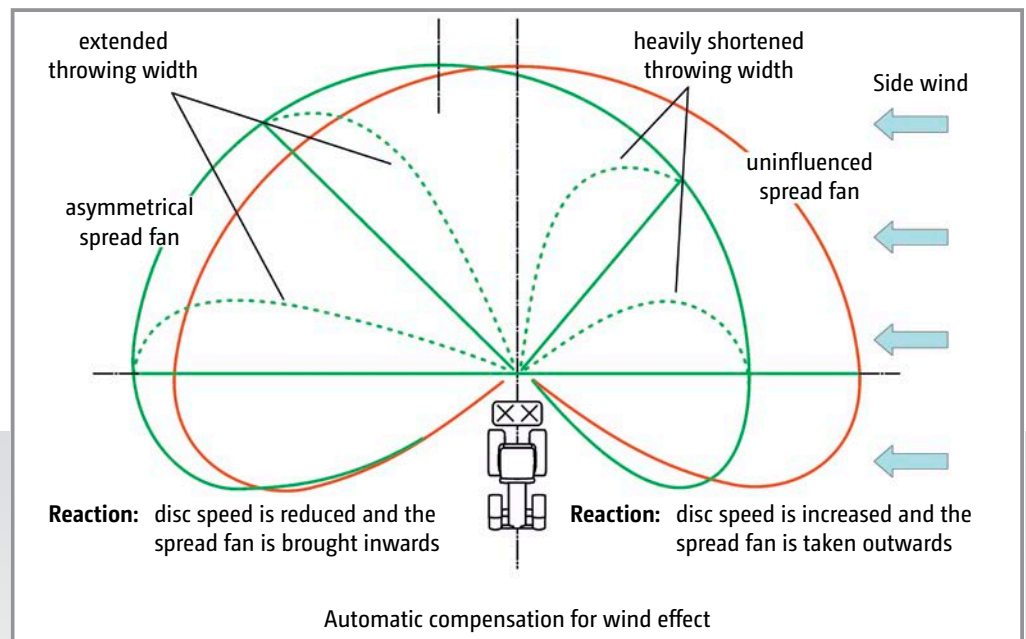

Equipment

Perfect down to the last detail



✔ Position indicator for the bed spread deflector

SafetySet – Integrated as standard

The SafetySet, which is fitted as standard equipment ensures improved safety. The outer guard tube fulfils the accident prevention regulations. Large marker boards to the rear and the lighting equipment ensure more recognisability in road traffic.

Roll-over hopper cover

The roll-over hopper cover, either manually operated or hydraulically actuated from the tractor, is available for all S extensions and L extensions. It safely covers over the hopper access point and ensures, when compactly rolled in, the maximum filling opening. The roll-over hopper cover can also be combined with the bolt-on S 600 and L 800 extensions.



❗ “The roll-over cover is superb: it closes cleanly to, keeps the water out during a shower and does not interfere with the filling operation when open.”

(dlz agrar magazine – Long term test ZA-TS
“Wide throwing master” · 01/2016)

Position indicator for the border spreading systems

For checking the position of the border spreading system from the tractor cab, AMAZONE offers a specific position indicator. Via the mechanical display which is in sight to the front of the fertiliser spreader, the position can be comfortably monitored during the spreading procedure.

Swivel hopper cover

As a less expensive alternative to the roll-over hopper cover, a swivel hopper cover with large sight window can be chosen for the S-extensions.



Swivel hopper cover, in its maintenance position for a simpler internal cleaning



- ❗ “The robust (and steered at the front) rollers with brakes are swivelled in or out with a bold kick. There is no better way.”
(profi – Practice test “Four fertiliser spreaders in comparison” · 01/2016)

Swivel rolling and parking device

The swivel rolling and parking device facilitates the easy mounting on and off the tractor and manoeuvring in the yard. The castor wheels are quickly folded in and out and optimally protected from dirt. They are permanently mounted on the spreader – so no need to search for them between one location and another.

Calibration kit

For the comfortable spread rate check without removal of the spreading disc, the lateral calibration kit, left or right hand side, is available.



Calibration kit

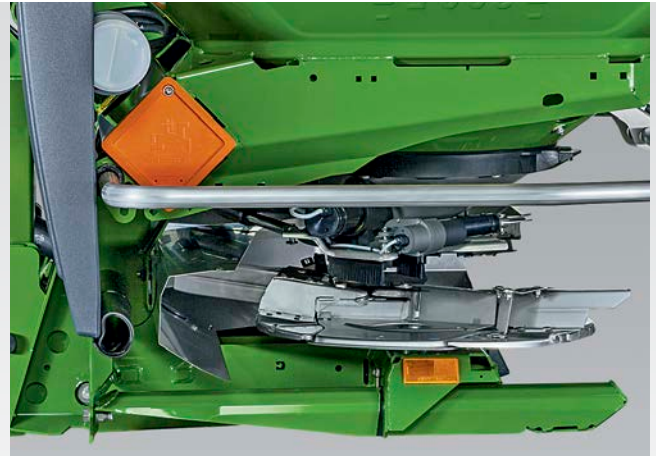

- ✔ Parking set with integrated stands

Parking stands

As an alternative to the swivel rolling and parking device, a cheaper parking set with integrated stands is also available.

Ladders that ensure a safe access

For optimum access to the hopper from outside, even on the narrow extensions, a ladder is available which can be fitted to the left and/or right hand side. For the wide L extensions though, ladders are provided to both sides as standard.



- ❗ “Even with the ladder Amazone sets the standard: fitted to both sides, the steps (from stainless steel!) are well integrated and do not protrude.”

(profi – Practice Test “Four fertiliser spreaders in comparison” · 01/2016)

ZA-TS model overview

Always the right choice



With the tractor ISOBUS base equipment, all the benefits of the ZA-TS can be utilised even on older tractors.

ISOBUS –

Machine actuation in the digital age

MEMBER OF



One language, many benefits!

Each ISOBUS-enabled machine from AMAZONE comes with the latest technology and almost unlimited possibilities. It does not matter whether you use an operator terminal by AMAZONE or an ISOBUS terminal directly installed in your tractor. ISOBUS is a worldwide recognised communication standard between, on the one hand, operator terminal, tractor and connected implements and, on the other hand, agricultural office software.

Operation with any ISOBUS terminal

Which means that ISOBUS enables you to take control of all your ISOBUS compatible equipment. You just connect the machine with the relevant ISOBUS terminal and immediately the normal operator interface is displayed on the monitor screen in your tractor cab.

Benefits of ISOBUS:

- ✔ This worldwide standard provides a uniform interface and data exchange formats that ensure the compatibility even with third party manufacturers
- ✔ Plug and Play between machine, tractor and additional ISOBUS implements



AMAZONE – more than just ISOBUS

Improved control, more yield! Precision Farming 4.0

Our competence in electronics

To increase the operational comfort, AMAZONE implements and operator terminals feature a scope of functionality way beyond ISOBUS standards.

The benefits of more than just ISOBUS:

- ✔ Highest compatibility and safety functionality of your ISOBUS equipment
- ✔ No additional modules on the machine side. All ISOBUS machinery from AMAZONE is already equipped as standard with the necessary ISOBUS functions
- ✔ MiniView display with all AMAZONE terminals and additional ISOBUS terminals. See, for instance, the machine data in the GPS view
- ✔ The possibility using the tractor terminal or in a twin terminal solution to separate the functionalities of tractor and connected implement
- ✔ Unique operation concept. Freely-configurable displays and individual user interfaces in the operator terminal
- ✔ Up to 3 user profiles are possible. Establish for every driver or operation an individual user profile!
- ✔ Freely-configurable machine operation as, for instance, the folding procedure of the booms of your AMAZONE crop protection sprayer
- ✔ Tractor ECU function evaluation
Automated movement sequences such as automated blocking of the steering axle while reversing
- ✔ Integrated TaskController data logger. As a matter of principle, every ISOBUS telemetry solution is possible (for example, TONI telemetry from CLAAS).
- ✔ Freely-configurable part-width sections



Make the most of the possibilities

Job management and documentation

All standard ISOBUS terminals from AMAZONE can collect and save machine and site-specific data using Task Controller. The collected data can subsequently be used in your Farm Management Information System.

- ✔ Easily compile or load jobs
- ✔ Processing jobs
- ✔ Document and export the work performed
- ✔ Processing of application maps in an ISO-XML format

GPS-Track

The GPS-Track parallel tracking aid makes orientation in the field much easier, particularly on grassland or in areas without tramline tracks. It has various track modes such as A-B Line and contour lines. Deviation from the ideal track is graphically shown on the display by an integrated light bar. Thanks to the clear steering recommendations with exact tramline distances you always remain on track!

- ✔ The virtual light bar in the status bar
- ✔ Standard for AmaPad 2
- ✔ Optional for the AmaTron 4

GPS-Track – your parallel driving aid in the field

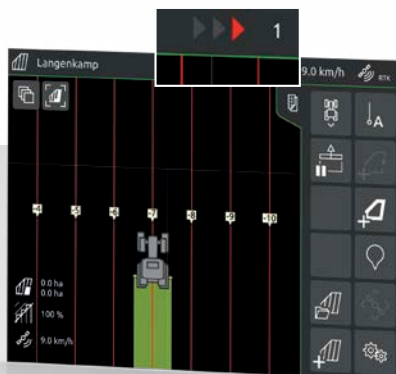

GPS-Maps

GPS-Maps enables uncomplicated part-area site specific management because this software module provides easy use of application maps in a shape file format. Either the target amount of the material to be applied or the target amount of effective ingredient can be directly processed.

- ✔ Intuitive system for working from application maps
- ✔ Automatic part-area site specific regulation of the application rate
- ✔ Optimum crop management via need-oriented application
- ✔ Standard on AmaTron 4 and AmaPad 2



GPS-Maps – part-area, site specific application



agrirouter –

The independent data hub for agriculture



Simple and safe data exchange

agrirouter can work with products and services from different manufacturers and facilitates universal data exchange for AMAZONE. agrirouter provides a safe and easy way to exchange data between AMAZONE machines, agricultural software, manufacturers and companies.

Full control – choose for yourself!

agrirouter simplifies data exchange by allowing wireless exchange of job data and application maps between AMAZONE machinery. It simplifies operating procedures, reduces administrative effort and improves profitability. You retain control of the data and decide who gets which data and to what extent.

Advantages of agrirouter:

- ✔ Simple and easy handling
- ✔ Comfortable and fast transfer
- ✔ Full control of your data
- ✔ Data are transferred, not stored
- ✔ Manufacturer-independent use

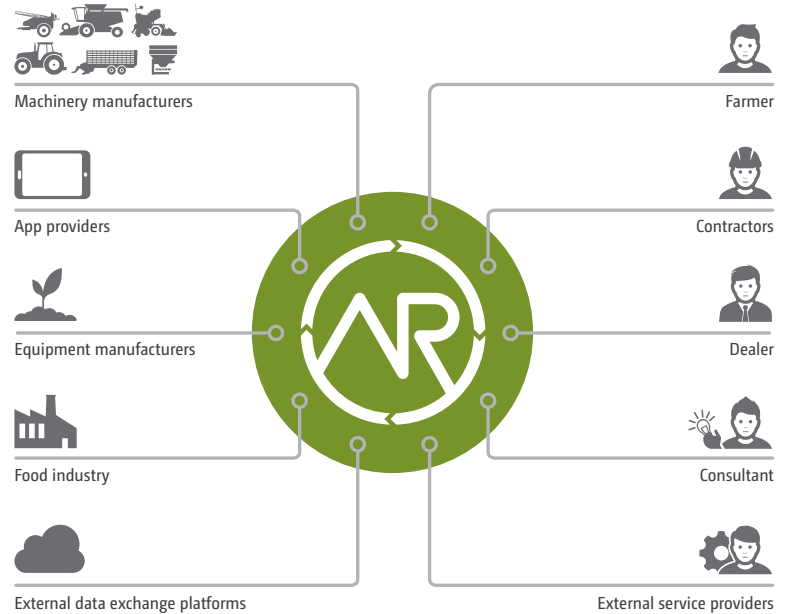

Source: DKE-Data GmbH & Co. KG



AMAZONE implements the connection to ISOBUS machine by using the AmaTron 4

Automatic GPS-Switch part-area shut-off with Section Control

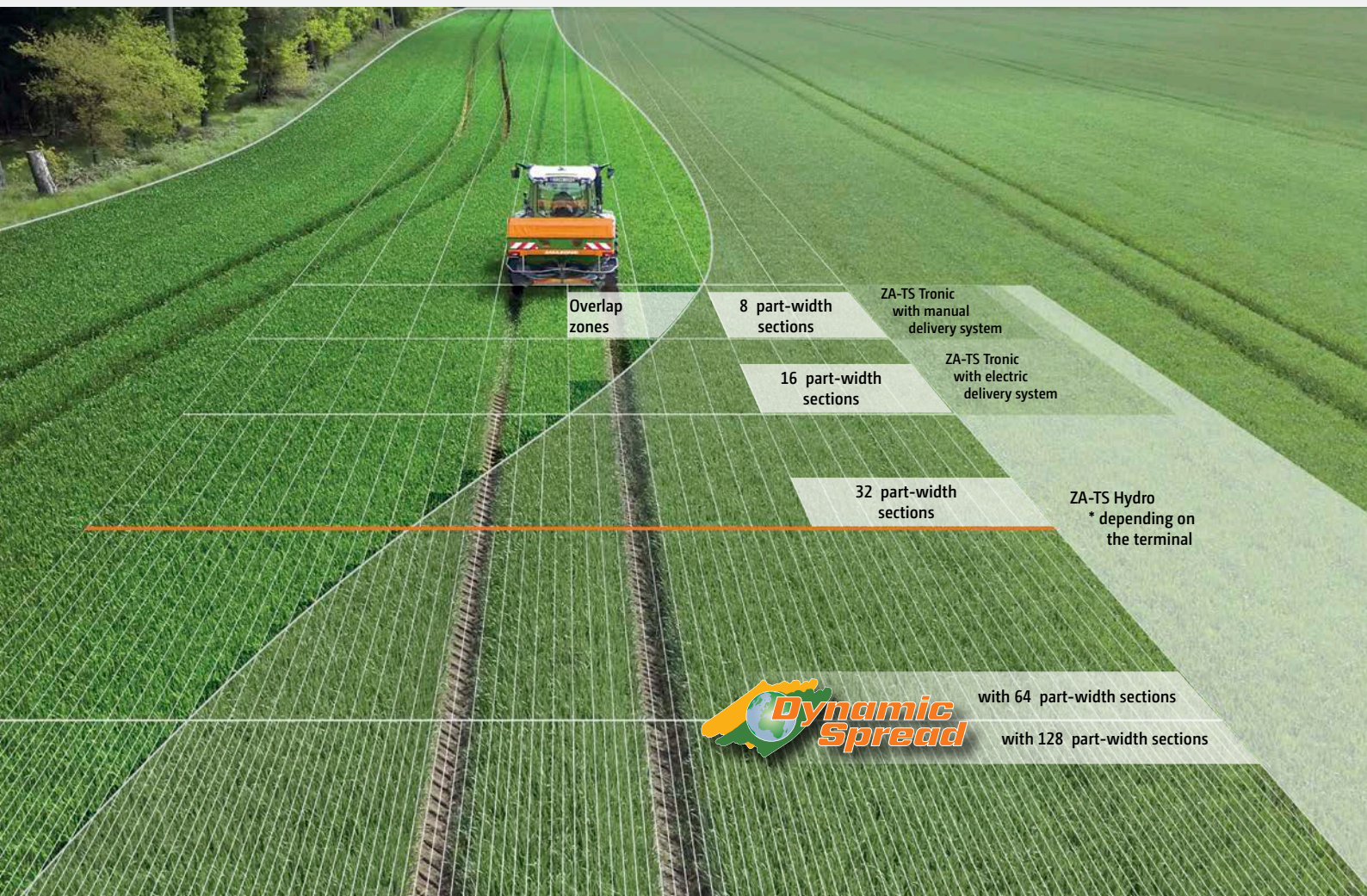

✔ With DynamicSpread, individual outlying part-width sections can also be controlled.

More precision, more efficiency!

In view of the very large working widths used now, the matching of the spread patterns is very important. Thanks to the electric delivery system adjustment on the TS spreading system, it is able to react precisely and sensitively in these cases. So even outer part-width sections can be easily controlled. In addition, due to the individual speed adjustment of the left and right hand side discs, the spreading width can be reduced from the far outside

to the centre, so that, even at large working widths, long and shallow-shaped wedges and short work are optimally spread. This means part-width section control. At the simplest level of specification, 8 part-width sections can be easily actuated manually (via the operator terminal). When utilising a relevant Section Control licence on the terminal, a part-width section control of up to a maximum of 128 part width sections can be utilised.

Part-width section control for ISOBUS fertiliser spreaders	ZA-TS Tronic Manual delivery system adjustment	ZA-TS Tronic Electric delivery system adjustment	ZA-TS Hydro Manual delivery system adjustment	ZA-TS Hydro Electric delivery system adjustment
Spread rate regulation	X	X	X	X
Setting the delivery system		X		X
Matching the spreading disc speed			X	X
Number of part-width sections • Manual mode via key pressure • Automatic mode via SectionControl/GPS-Switch	8 In manual and automatic mode	8 In manual mode 16 In automatic mode	8 In manual mode up to 128 In automatic mode	8 In manual mode up to 128 In automatic mode
Possible working widths	15–54 m	15–54 m	15–54 m	15–54 m

Automatic part-width section control

If the terminal to be operated features Section Control, such as, for example, GPS-Switch part-width section control from AMAZONE, the switching of the part-width sections can be carried out completely automatically and in relation to the GPS position. Once a field has been established by the driver, then, in the automatic mode, they can fully concentrate on handling the vehicle whilst the switching of the part-width sections in wedges and on the headland is carried out automatically.

Benefits of automatic part-width section control:

- ✔ Stress relief on the driver
- ✔ Increase in precision especially at night or at higher speeds
- ✔ Less overlaps and gaps
- ✔ Saving of resources
- ✔ Less crop damage and environmental pollution

❗ “With Section Control, the ISOBUS computer relieves the driver from a lot of work.”

(“dlz agrar magazine“ – “Test report ZA-TS fertiliser spreader“ · 02/2017)

GPS-Switch

With GPS-Switch, AMAZONE offers a GPS-based, fully automatic, part-width section control for all AMAZONE operator terminals and ISOBUS compatible fertiliser spreaders, crop protection sprayers or seed drills.

GPS-Switch basic

- ✔ Automatic part-width section control of up to 16 part-width sections
- ✔ Optional for AmaTron 4

GPS-Switch pro

- ✔ Automatic part-width section control of up to 128 part-width sections
- ✔ Creation of a virtual headland
- ✔ Creation of Point of Interests (POI)
- ✔ Automated boom lowering for an AMAZONE sprayer
- ✔ Standard for AmaPad 2
- ✔ Optional for AmaTron 4

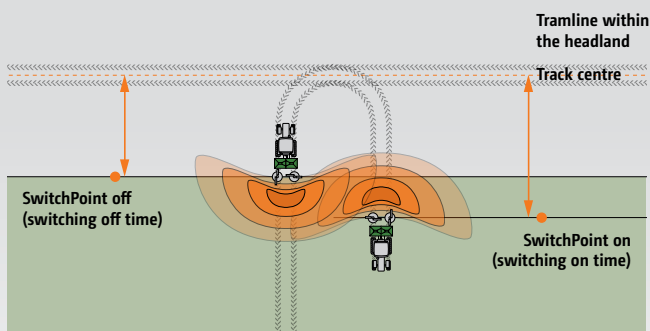

✔ SwitchPoint

SwitchPoint allows, when utilising GPS-Switch, to re-adjust the on/off switching points depending on the fertiliser type and the working width. Both values can be taken from the setting chart and entered into the relevant operator terminal.

ISOBUS terminals from Amazone

Intuitive, comfortable, better – workday made easy

From simple to high-tech – everything is possible

AMAZONE offers two particularly convenient operator terminals for your ISOBUS machinery in the form of the ISOBUS-compliant AmaTron 4 and the AmaPad 2. In addition to pure machine operation, there are additional application options, such as automated GPS-Switch part-width section control.

- ✔ All applications come pre-installed and can be initially tested free of charge
- ✔ Intuitive and clear actuation

Everything in view with the 2-terminal solution

As well as operating the AMAZONE ISOBUS machine through the tractor terminal, there is also the handy alternative of separating the functionalities of the tractor and the attached machine and operating them by using two terminals. The tractor terminal can continue to control the tractor or also display the GPS applications whereas the additional operator terminal in its UT display mode is fully utilised to monitor and control the machine.



Terminal	AmaTron 4	AmaPad 2
Display	8 inch, multi-touch colour display	12.1 inch, multi-touch-colour display
Mode of operation	Touch and 12 soft keys	Touch
Interfaces	1 x Ethernet 2 x RS232 (GPS & ASD) 2x USB interfaces	1 x Ethernet 2 x RS232 (GPS & ASD) 2x USB interfaces with WLAN dongle
Job management and processing of application maps (ISO-XML and Shape)	GPS-Maps&Doc * with integrated Task Controller	Task Controller
Parallel driving aid	GPS-Track * with virtual light bar	GPS-Track pro with virtual light bar
Automatic track following	–	GPS-Track Auto for the Pantera self-propelled crop protection sprayer
Automatic part-width section control (SectionControl) Note: dependent on the max. no. of sections of the machine!	GPS-Switch basic * with up to 16 part-width sections or GPS-Switch pro * with up to 128 part width sections	GPS-Switch pro with up to 128 part width sections
Camera connectivity	1x camera connection * with AmaCam automatic reversing detection	2x camera connections *

* = optional



Everything from a single source!

Thanks to the AUX-N feature, you can operate multiple functions of the machine via AmaPilot+ or any other ISOBUS multi-function joystick.



The benefits of AmaPilot+:

- ✔ Perfect ergonomics
- ✔ Almost every function directly controlled via 3 levels
- ✔ Adjustable palm-rest
- ✔ Freely-programmable, individual key layout
- ❗ "The joystick rests comfortably in the hand."
("dlz agrar magazine" – "Test report Pantera 450Z" · 02/2016)



- ❗ "The ISOBUS control is an in-house development from AMAZONE and has been designed clearly and is easily understandable. If desired, some keys can be freely allocated. Also the multi-function display can be freely selected."
("agrarteute" magazine – "Test report Centaya seed drill" · 06/2018)

AmaTron 4

Manager 4 all



Easy and comfortable operation as intuitive as your tablet

Why not handle a terminal as intuitively like a tablet or a smartphone? With this in mind AMAZONE has developed the highly intuitive and operator-friendly AmaTron 4 which offers a noticeably smoother operational process, especially when it comes to job management. The AmaTron 4, with its 8" multi-touch colour display meets the highest expectations and offers maximum user-friendliness. A swipe of the finger or using the App carousel allows quick changes between applications and the simple and clearly structured operating menu. A useful MiniView, a freely configurable status line as well as a virtual light bar make the use of the AmaTron 4 particularly clear and convenient.

Benefits of AmaTron 4:

- ✔ Automated full image mode during non-operation
- ✔ Practical MiniView concept
- ✔ Operation via the touch display or via soft keys
- ✔ Especially intuitive and user-friendly
- ✔ Field-related documentation
- ✔ Practice-oriented and intelligent menu guidance
- ✔ Day-night mode

Standard with:

GPS-Maps&Doc



- ✔ Automated AmaCam reverse driving recognition that gives direct access to a reversing camera and prevents dangerous situations

- ✔ Machine operation (UT, Universal Terminal) in day-night mode

AmaPad 2

The especially comfortable way to control agricultural machinery



The new dimension of control and monitoring

AmaPad 2 from AMAZONE is a particularly high-quality operator terminal. The 12.1" multi-touch colour display is particularly comfortable and fulfils the highest demands on Precision Farming. The operation of AmaPad is carried out solely via touch.

With the practical "MiniView concept", applications which aren't being actively operated at that moment but need to be monitored are clearly displayed at the side. When needed these can be enlarged via "a finger swipe". The possibility to individualise a "dashboard panel" with the displays of choice rounds up the user ergonomics.

In addition to the GPS-Switch pro part-width section control, GPS-Track pro, a high-end parallel tracking aid with virtual light bar is included in the standard specification.

Benefits of AmaPad 2:

- ✔ Large 12.1" multi-touch colour display
- ✔ Extended MiniView concept
- ✔ Upgrade to automatic steering is possible thanks to the automatic GPS-Track Auto track guidance
- ✔ Day-night mode

Standard with:

GPS-Maps pro
GPS-Track pro
GPS-Switch pro



Spreader Application Centre

Exemplary advice – for more than 25 years

The settings are crucial!

With the Spreader Application Centre, AMAZONE offer even better customer service. In addition to the already well-established fertiliser laboratory and spreading hall, the Spreader Application Centre now also includes the areas of “Test and Training”, “Data management” and the relevant “Knowledge transfer”.

The two last areas are accompanied by a reorganisation that caters for the increasing globalisation and digitalisation of agriculture. The aim of the Spreader Application Centre is to offer to the customer an even better service with regard to fertiliser application.



Fertiliser laboratory



Spreading hall



Test and Training

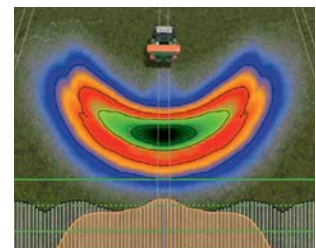

Data management and knowledge transfer

FertiliserService – You can contact us via:

The FertiliserService works beyond limits. Because no matter whether your fertiliser spreader is 5 or 50 years old, we are always by your side with competent and reliable assistance.

Internet: www.amazone.de
 ✉ E-Mail: duengeservice@amazone.de
 ☎ Telephone: +49 (0)5405 501-111
 📞 WhatsApp: +49 (0)175-488 9573

Also available via an App for iPhone and other Smartphones.



Android equipment



iOS equipment

Only when properly spread is your fertiliser worth its weight in gold

The AMAZONE FertiliserService closely cooperates with well-known manufacturers of spreading material – worldwide to be able to make available to you the best setting values as quickly as possible. AMAZONE is the name for precise spreading charts, worldwide.

📌 "Depending on the area applied, a theoretical gain of 100 to 1,000 euros per hour can be achieved with a perfectly adjusted fertiliser spreader."

("agrarheute" magazine - Set out the trays and earn money - 02/2019)

EasyCheck

Precise spreading made easy!



Digital, mobile test kit for the easy optimisation of the lateral distribution

Instead of testing trays, such as those found in the normal mobile test kit, the EasyCheck system consists of just 16 lightweight test mats made from rubber and the EasyCheck App for Smartphones. The test mats are positioned in pre-determined distances away from the tramline. Then the relevant tramline is spread and the mats with the fertiliser granules laying on them are photographed. The App now compares automatically how much fertiliser has been collected on each test mat and sets the results of the individual rows to an average. In cases where the spreading results are not the optimum, the App suggests readjustments for the setting of the relevant fertiliser spreader.



EasyCheck – Smartphone App for fertiliser spreaders

- 1 The new EasyCheck rubber mats from Amazone offer many advantages here. They are smaller and easier to handle.” (“*agrarteute*” magazine - Set out the trays and earn money - 02/2019)

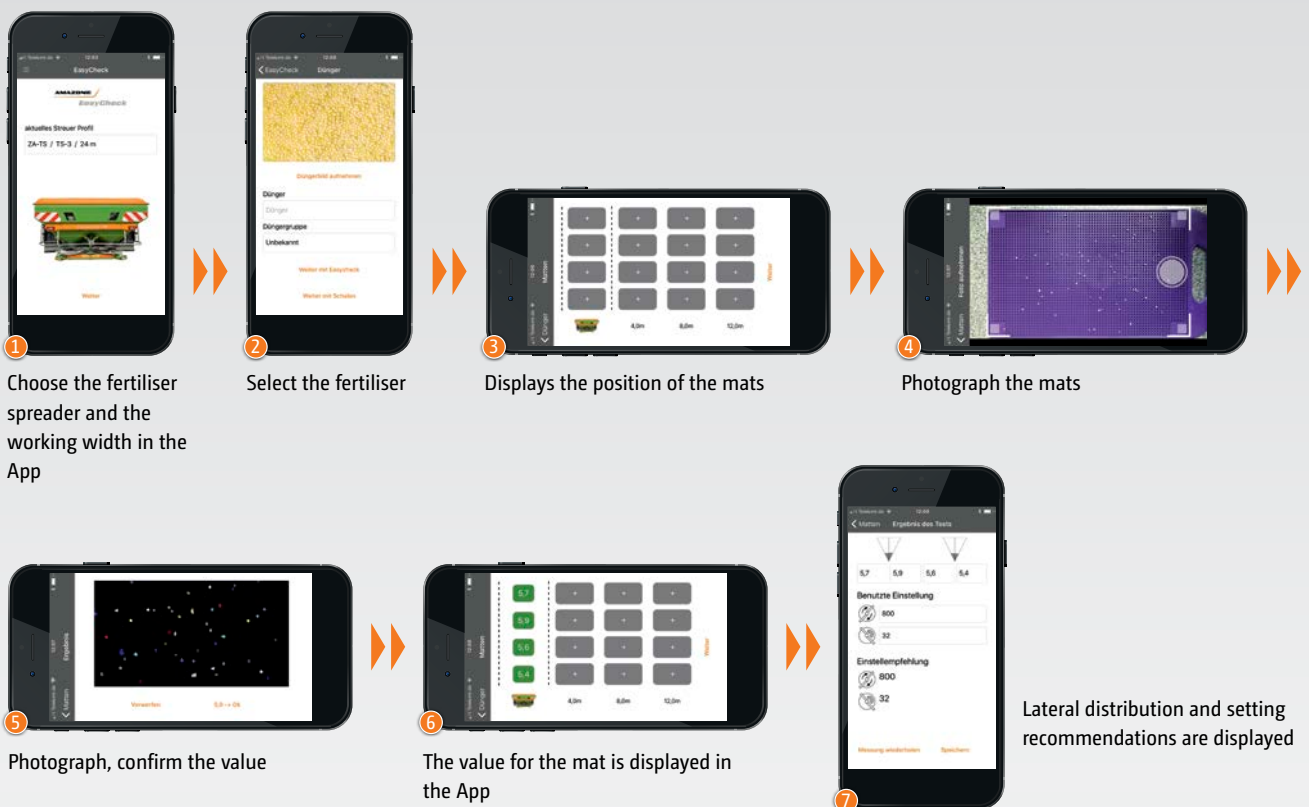

Technical data

ZA-TS	1400	1700	2000	2200	2600	2700	3200	4200
Working width (m)	15–54							
Hopper volume (l)	1,400	1,700	2,000	2,200	2,600	2,700	3,200	4,200
– with S 600 hopper extension (l)	2,000	2,300	2,600	–	–	–	–	–
– with L 800 hopper extension (l)	–	–	–	3,000	–	3,500	4,000	–
Payload (kg)	Super frame	3,200	3,200	3,200	3,200	3,200	3,200	–
	Ultra frame	–	–	–	4,500	–	4,500	4,500
Filling height (m) without rolling & parking device	1.13	1.23	1.31	1.30	1.49	1.42	1.54	1.76
Filling width (m)	2.23	2.23	2.23	2.72	2.23	2.72	2.72	2.72
Total width (m)	2.55	2.55	2.55	2.92	2.55	2.92	2.92	2.92
Total length (m) without weighing system	1.48	1.46	1.46	1.55	1.46	1.55	1.55	1.68
Drive	mechanical (Tronic)/hydraulic (Hydro)							
Weighing system	optionally with Profis weighing system							
Regulating electronics	ISOBUS communication via AmaTron 4, AmaPad or any other ISOBUS terminal							
Lower linkage	Super frame	Cat. II linkage dimensions and fixing pins						
	Ultra frame	Cat. III linkage dimensions, fixing pins Cat II or III						
Tractor valves required	ZA-TS Tronic	Not necessary, (1 d/a valve for hyd. rollover cover)						
	ZA-TS Hydro	1 s/a valve + pressure-free return or load sensing for drive (oil capacity 70 l/min), (1 d/a valve for hyd. rollover cover)						
Min. weight (kg) (with spreading vane set TS 2)	471	480	489	539	528	555	573	685

Illustrations, content and technical data are not binding! Deviations of technical data are possible depending on the equipment. The illustrations may deviate from the requirements for local road traffic regulations.

ZA – the spreader



AMAZONEN-WERKE H. Dreyer GmbH & Co. KG
P. O. Box 51 · D-49202 Hasbergen-Gaste/Germany
Phone: +49 (0)5405 501-0 · Fax: +49 (0)5405 501-193